

NIST

CYCLE_D:

NIST Vapor Compression Cycle Design Program

Version 4.0

Users' Guide

J.S. Brown, Ph.D., P.E.
The Catholic University of America
Washington, DC

P.A. Domanski, Ph.D.
Building and Fire Research Laboratory
National Institute of Standards and Technology
Gaithersburg, MD

E.W. Lemmon, Ph.D.
Thermophysical Properties Division
National Institute of Standards and Technology
Boulder, CO

May 2009

U.S. Department of Commerce
National Institute of Standards and Technology
Standard Reference Data Program
Gaithersburg, MD 20899

The National Institute of Standards and Technology (NIST) uses its best efforts to deliver a high quality copy of the Database and to verify that the data contained therein have been selected on the basis of sound scientific judgment. However, NIST makes no warranties to that effect, and NIST shall not be liable for any damage that may result from errors or omissions in the Database.

NIST Standard Reference Database 23 -(c) 1989, 1991, 1993, 1998, 2003, 2009 copyright by the U.S. Secretary of Commerce on behalf of the United States of America. All rights reserved. No part of this database may be reproduced, stored in a retrieval system, or transmitted, in any form or by any means, electronic, mechanical, photocopying, recording, or otherwise, without the prior written permission of the distributor.

Certain trade names and company products are mentioned in the text to specify adequately the computer products and equipment needed to use this software. In no case does such identification imply endorsement or recommendation by the National Institute of Standards and Technology of these computer products and equipment, nor does it imply that the products are necessarily the best available for the purpose.

Microsoft is a registered trademark, and Windows is a trademark of the Microsoft Corporation. All other brand and product names are trademarks or registered trademarks of their respective companies.

ACKNOWLEDGMENTS

Version 1.0 of CYCLE_D, authored by J. Chi, D.A. Didion, and P.A. Domanski, was developed in 1992 under partial funding from the Trane Company and the Electric Power Research Institute, with G. Lange and T. Statt managing the project. The authors acknowledge helpful suggestions from P. Glamm. J. Wnek made modifications and improvements of the graphical user interface in Version 2.0, and J. Schnotale and P.A. Domanski implemented thermodynamic charts and line sizing calculations in Version 3.0. For Version 4.0, J. S. Brown extended simulation options to include transcritical cycles, cycles with two-stage compression with intercooling, and two and three-stage economizer cycles; and E. W. Lemmon provided new thermodynamic charts. The authors acknowledge K. Tchen's assistance in upgrading the graphical user interface, and J. Calm, D. Yashar, B. Dougherty, and T. Watson for their testing and comments on the program.

CONTENTS

INTRODUCTION.....	1
SYSTEM REQUIREMENTS.....	1
INSTALLATION.....	1
MODELING APPROACH	2
Refrigerants and Refrigerant Properties.....	2
Condenser (or Gas Cooler) and Evaporator	2
Compressor	3
Economizer(s) and Intercooler	4
Suction Line and Discharge Line.....	4
Liquid-Line/Suction-Line Heat Exchanger	4
Indoor Fan, Outdoor Fan, and Controls	5
Refrigerant Line Sizing Calculations	5
Simulation Results	6
Uncertainty of Simulation Results	6
USE OF CYCLE_D	7
Specifying User's Options	7
Entering New Input Data	9
Refrigerant Tab	9
Cycle Options Tab	14
System Specifications Tab	15
Using Compressor Maps	16
Entering Data for Transcritical Cycle	16
Loading an Existing File with Input Data	17
Executing a Simulation Run	18
Presenting Simulation Results	18
Summary Results.....	18
System Schematic Window	19
State Diagram Windows	20
Line Sizing Information	22
Saving Input Data	23
Diagnostic Messages	23
Help Menu	23
REFERENCES.....	25

Appendix A.	SINGLE-COMPOUND REFRIGERANTS AVAILABLE IN CYCLE_D	26
Appendix B.	PREDEFINED REFRIGERANT BLENDS AVAILABLE IN CYCLE_D	28
Appendix C.	COMPRESSOR MAPS	30
	Compressor Map Formats	30
	Preparing a New Compressor Map	31
Appendix D.	NOMENCLATURE USED FOR REPORTING SIMULATION RESULTS	33
Appendix E.	UNITS, CHECKS AND WARNINGS	34
Appendix F.	CONTACTS.....	36

INTRODUCTION

The CYCLE_D package simulates vapor compression refrigeration cycles that use pure refrigerants or mixtures of refrigerants. The model can simulate a basic subcritical or transcritical refrigeration cycle, both with or without a liquid-line/suction-line heat exchanger. In addition, the model can simulate a subcritical two-stage economizer cycle, a subcritical three-stage economizer cycle, and a subcritical two-stage compression cycle with intercooling. CYCLE_D operates in a user-friendly Microsoft Windows environment that facilitates evaluating the performance of selected working fluids at different operating conditions. Calculations are based on refrigerant properties as represented in the NIST Reference Fluid Thermodynamic and Transport Properties Program – REFPROP, Version 8.0 [1].

SYSTEM REQUIREMENTS

CYCLE_D is designed to run on any personal computer capable of running Microsoft® Windows™ 98, 2000, NT and XP operating system. A hard disk with eight megabytes of available space is required. The screen resolution should be set to 800 x 600 or higher to view images in their entirety.

INSTALLATION

Insert the CD-ROM in drive (D or E). In Microsoft Windows click on the Start button and select Run. In the edit box, type, as appropriate,

D:\SETUP or E:\SETUP

and press **ENTER**. Follow the remainder of the installation instructions. A NIST CYCLE_D Program Group will be created at the end of the installation.

To run the program, double-click on the NIST CYCLE_D icon.

MODELING APPROACH

The basic subcritical or transcritical system simulated by CYCLE_D consists of a compressor, a discharge line, a condenser for the subcritical cycle (a gas cooler for the transcritical cycle), an expansion device, an evaporator, a compressor suction line, and an optional liquid-line/suction-line heat exchanger. The other subcritical cycles may contain a second compressor, and one or two economizers or an intercooler. These cycles, however, do not include the optional liquid-line/suction-line heat exchanger. The user of the program has to specify the refrigerant and provide input data for the above hardware components, except the expansion device, which is modeled as being isenthalpic. The user can also specify the power requirements of the indoor fan, outdoor fan, and control unit of the system.

Refrigerants and Refrigerant Properties

CYCLE_D includes 48 single-compound refrigerants, which can be selected as the working fluid. These pure refrigerants can also be combined to form blends of up to five components. In addition, CYCLE_D includes 54 predefined mixtures. See Appendix A for the list of available pure refrigerants and Appendix B for the list of available predefined refrigerant mixtures.

CYCLE_D uses REFPROP 8.0 [1] routines for calculating thermodynamic properties of pure refrigerants and refrigerant mixtures and applies the default models (recommended in REFPROP) for property predictions.

Condenser (or Gas Cooler) and Evaporator

The condenser and evaporator are represented by specifying the refrigerant temperature in each of these heat exchangers. The gas cooler is represented either by specifying the refrigerant pressure or allowing the program to optimize the refrigerant pressure, and the refrigerant exit temperature. Zero refrigerant pressure drop is assumed in each heat exchanger.

The refrigerant temperature in the condenser can be specified to be either a bubble-point temperature, a dew-point temperature, or an average temperature. The average temperature is calculated as an arithmetic mean of the dew-point and bubble-point temperatures. Additionally, refrigerant subcooling at the condenser outlet can be specified.

The refrigerant temperature in the evaporator can be specified as either a dew-point temperature or an average temperature. The average temperature in the evaporator is calculated as an arithmetic mean of the dew-point temperature and the temperature of the refrigerant entering the

CYCLE_D 2

evaporator. Additionally, the refrigerant superheat at the evaporator exit can be specified.

The above options for specifying the evaporator and condenser temperatures have no significance for single-component refrigerants, but they affect simulations with zeotropic mixtures since zeotropic mixtures undergo a temperature change during a phase change.

The use of an average temperature in the condenser and evaporator as a mean of refrigerant temperatures at the end of two-phase processes is a simplification for zeotropes whose temperature profile versus enthalpy in a two-phase region is not linear. However, this method is used to make CYCLE_D mimic the method used by industry for compressor calorimeter testing.

Compressor

For a basic subcritical cycle, CYCLE_D provides two options for representation of the compressor: the "Compressor Efficiency" option and the "Compressor Map" option. For other subcritical cycles and for the transcritical cycle, only the "Compressor Efficiency" option is available.

The "Compressor Efficiency" option requires input values of isentropic efficiency, compressor volumetric efficiency, electric-motor efficiency, and a target system **Cooling Capacity**, which is the evaporator capacity adjusted for the heat added by the indoor coil fan. If the used value of the electric motor efficiency is less than unity, the entire heat rejected by the electric motor is assumed to heat the suction vapor before the compressor suction port. If the cycle includes two compressors, their inputs have to be independently specified.

The "Compressor Map" option uses compressor-map correlations, which are typically derived from compressor calorimeter tests. Three types of correlations are allowed. They are described in Appendix C.

The "Compressor Map" option also requires a value for either the system **Cooling Capacity** or **Capacity Multiplier**. If **Capacity Multiplier** is specified, its value is used in the simulation as a multiplication factor for compressor capacity (calculated by compressor-map correlations) and for indoor and outdoor fan powers (entered by the user). Power input to the system control unit is unaffected. If the system **Cooling Capacity** is specified, the simulations are performed for a system with a compressor of identical efficiency characteristics but with adjusted displacement, so that the system can provide the specified capacity. The power input to the indoor and outdoor fans and system control unit are unaffected by the specified capacity value.

Compressor-map equations correlate the compressor performance at certain suction superheat and condenser subcooling. To allow simulations at user-specified conditions, the following steps and assumptions are taken by the model:

- The isentropic efficiency of the compressor is calculated using the compressor-map correlations at user-specified saturation temperatures (or pressures) and at the superheat and subcooling levels used during the calorimeter tests. It is assumed that the isentropic efficiency is not affected by the level of superheat, and the calculated efficiency value is used in the cycle calculations.
- When calculating the refrigerant mass flow rate, it is assumed that the compressor volumetric efficiency and speed (revolutions per minute, RPM) are not affected by the suction vapor superheat. Consequently, the refrigerant mass flow rate at the user-specified superheat equals the value of mass flow rate at the superheat set during the calorimeter tests, adjusted for the different specific volume of the suction vapor caused by a different superheat.

Economizer(s) and Intercooler

These intermediate system components are represented by specifying the refrigerant pressures. For the two-stage economizer cycle, the program can impose or optimize the intermediate pressure of the economizer.

Suction Line and Discharge Line

The pressure drop in the suction and discharge lines can be specified by assigning a value of the corresponding saturation temperature drop of the refrigerant. CYCLE_D assumes the lines are adiabatic.

Liquid-Line/Suction-Line Heat Exchanger

The liquid-line/suction-line heat exchanger (LLSL-HX) is specified by the user by assigning an effectiveness value of the heat exchanger. The assignment of zero effectiveness denotes no LLSL-HX in the cycle.

Indoor Fan, Outdoor Fan, and Controls

CYCLE_D 4

The auxiliary powers are specified by the user. The indoor and outdoor fan powers are used in the total power calculation and as heat in the capacity calculations for the evaporator and condenser. The control unit power is only used in the total power calculation.

Refrigerant Line Sizing Calculations

After cycle calculations have been completed, CYCLE_D can provide sizing information for the compressor suction and discharge lines and for the liquid line connecting the condenser and expansion valve. This information includes refrigerant velocity and tube lengths, and is provided for a range of diameters of straight type L copper tubing. The refrigerant mass flow rate determined during cycle simulations is used in these calculations.

The refrigerant velocity values presented by CYCLE_D are those at tube inlets. Refrigerant velocity varies in a tube because of a pressure drop and change of specific volume. The lowest velocity, critical to oil return, is at the tube inlet because of the lowest specific volume.

The program calculates tube lengths for the respective pressure drops imposed by the user in the simulated cycle (system). For the suction and discharge lines, these pressure drops are specified in the System Specifications tab in terms of the refrigerant dew point temperature drop. For the liquid line, CYCLE_D calculates the line length for the pressure drop that would result in bringing the subcooled refrigerant to flashing. Tube length calculations assume lubricant-free refrigerant flowing in adiabatic tubes, and use refrigerant parameters corresponding to the average of the inlet and outlet pressures.

The program does not provide line length values for zero pressure drops; i.e., for zero condenser subcooling for the liquid line, and for zero drop in saturation temperatures for the vapor lines. Also, the program does not provide results for the liquid and suction lines if the system employs a liquid-line/suction-line heat exchanger.

Note that CYCLE_D performs refrigerant line sizing calculations using several simplifications. The line sizing information is provided by CYCLE_D for general orientation and should not be used as strict design criteria for field application.

Simulation Results

Simulation results are generated in two categories: (1) for the thermodynamic cycle and (2) for the compressor and system. The cycle category presents the results obtained per unit mass of refrigerant. These results reflect refrigerant parameters only and are not affected by the auxiliary power input to the indoor fan, outdoor fan, and controls. The compressor and system results are calculated for the system **Cooling Capacity** or **Capacity Multiplier** as specified by the user. CYCLE_D calculates line sizing information using the thermodynamic parameters identified throughout the cycle and the refrigerant mass flow rate needed to obtain the target system capacity. The naming convention used for simulation results is explained in Appendix D.

Uncertainties in Simulation Results

Uncertainties in the simulation results are directly related to the uncertainties of thermodynamic properties calculated by REFPROP 8.0 [1] property routines incorporated into the CYCLE_D package. CYCLE_D uses the REFPROP default property models, which should provide the most accurate predictions. The user should be aware that the uncertainties in these models vary somewhat depending on the refrigerant, property, and thermodynamic state. It is thus impossible to give a simple, global statement of uncertainties. Even for the most-studied fluids with equations of state based on accurate, wide-ranging data, uncertainties are complicated functions of temperature and pressure. For details, refer to the original literature sources listed in [1].

USE OF CYCLE_D

This section explains how to use CYCLE_D: how to specify a cycle/system; how to run a simulation; how to present simulation results; and how to manage input/output files. If the user needs additional information after going through this tutorial, he or she may refer to CYCLE_D's on-line help.

Once CYCLE_D is properly installed on your computer, it can be started by double clicking on the **CYCLE_D** icon. The opening screen is displayed first. Click on the **OK** button to proceed. After doing so, the main CYCLE_D screen appears. Figure 1 shows the main screen after a new session has been started and the user has clicked on the 'Options' pull down menu. It is practical to set the user's preferences.

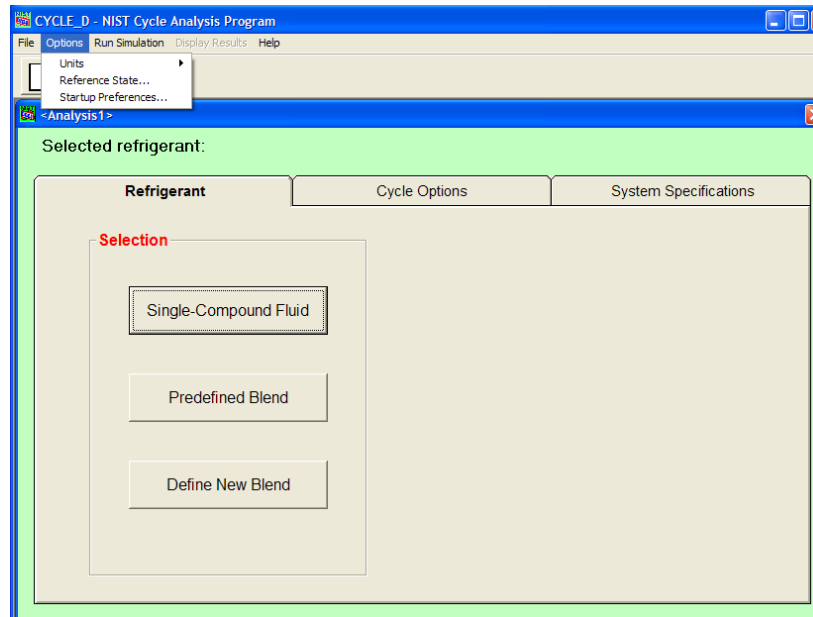

Figure 1. Main window with activated Options pulldown menu

Specifying User's Options

To select either SI or Inch-Pound (I-P) units, click the **Options/Units** menu item. There are three options for units: (1) SI with temperatures specified in K, (2) SI with temperatures specified in °C, or (3) I-P with temperatures specified in °F.

To select the reference state for enthalpy and entropy calculations [1], click on the **Options/Reference State** menu item, after which Figure 2 appears. Note: the reference states are completely arbitrary; however, three common ones are provided: (1) setting enthalpy and entropy values to zero at the normal boiling point, (2) ASHRAE convention, or (3) International Institute of Refrigeration (IIR) convention. The first radial button option, if selected, uses the REFPROP 8.0 [1] default reference state for that particular refrigerant.

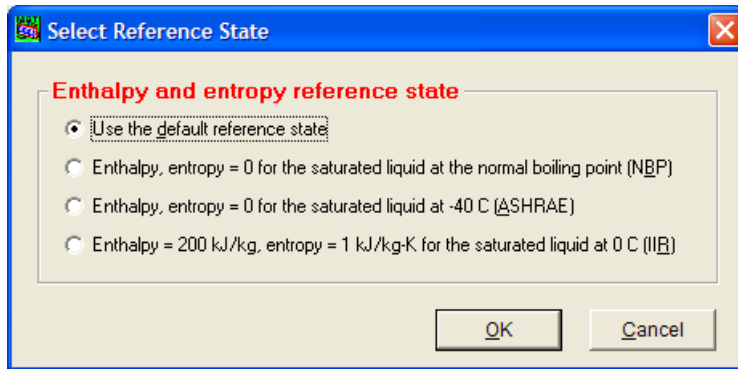

Figure 2. Selecting reference state for enthalpy and entropy calculations

Figure 3 shows the choices for **Startup Preferences**. When the user sets the option to load an initial file (which could be the last file used or a default file), the units and reference state preferences stored in this file become the current preferences for a given session. If desired, these preferences can be changed manually using the **Options** pulldown menu. Note that loading any existing file anytime during a simulation session will change the current preferences for this session to those stored in the loaded file.

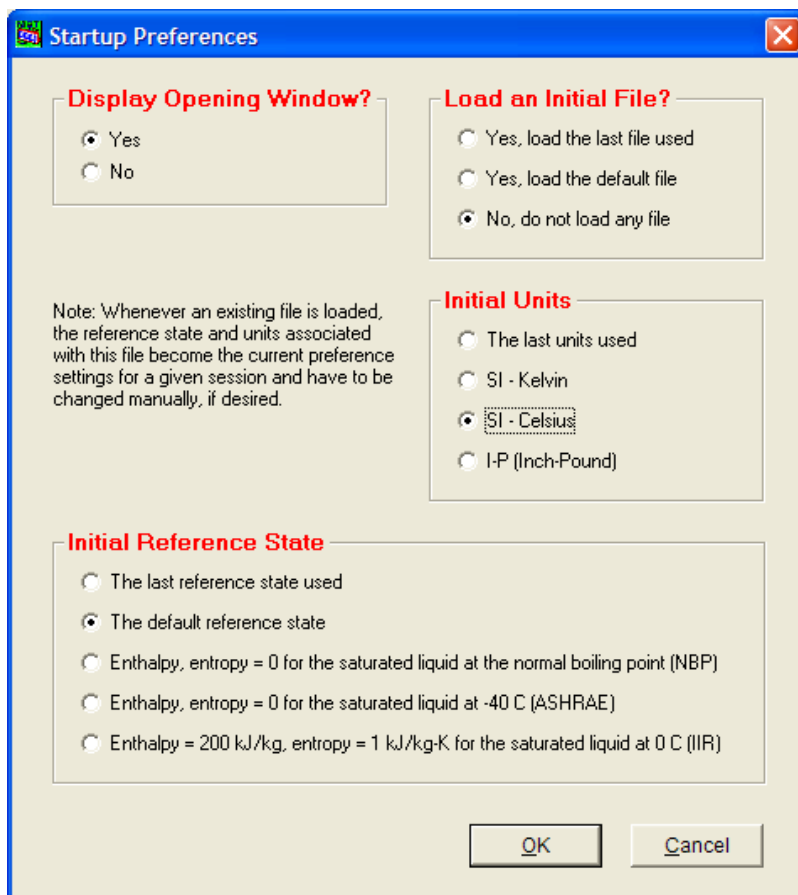

Figure 3. Startup Preferences

Entering New Input Data

To enter new data, the user needs to use the three tabs titled **Refrigerant**, **Cycle Options**, and **System Specifications** shown in Figure 1. The sequence of using these tabs is arbitrary.

Refrigerant Tab

The **Refrigerant** tab provides three options: (1) **Single-Compound Fluid** (Figure 4), (2) **Predefined Blend** (Figure 6), and (3) **Define New Blend** (Figure 8).

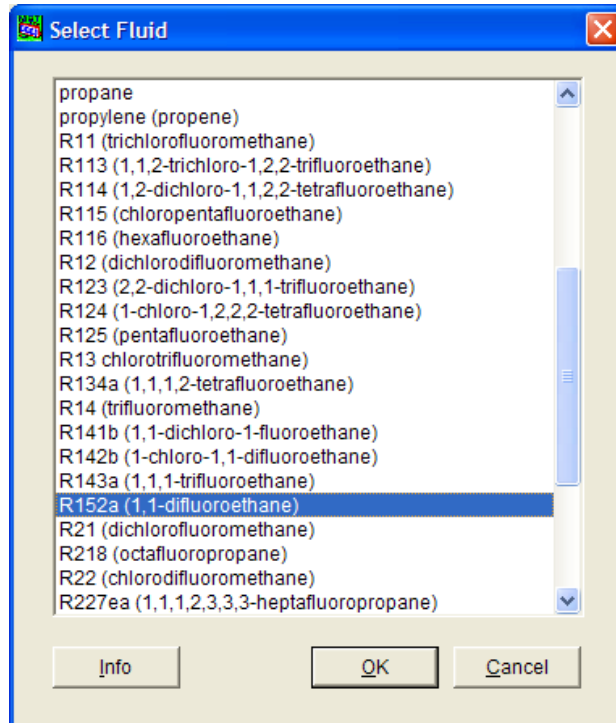

Figure 4. Selecting a single-compound fluid

The user may click the **Info** button, shown in Figures 4 and 6, to display information for the selected refrigerant, shown in Figures 5 and 7 for a single-compound fluid and predefined blend, respectively.

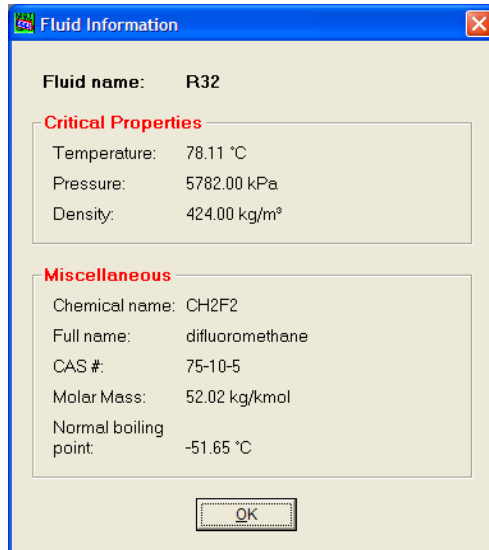

Figure 5. Information for a single-compound fluid

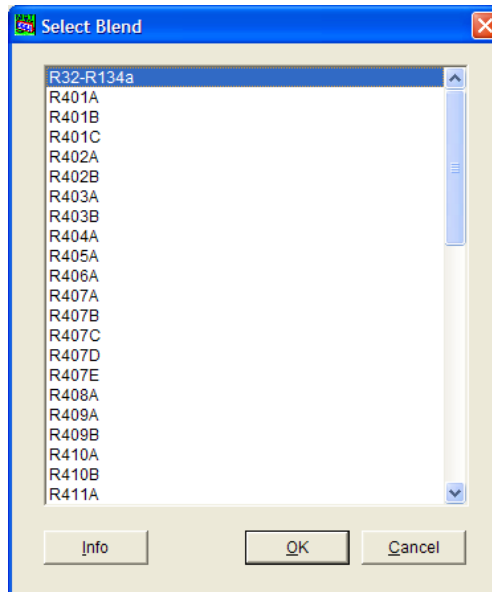

Figure 6. Selecting a predefined blend

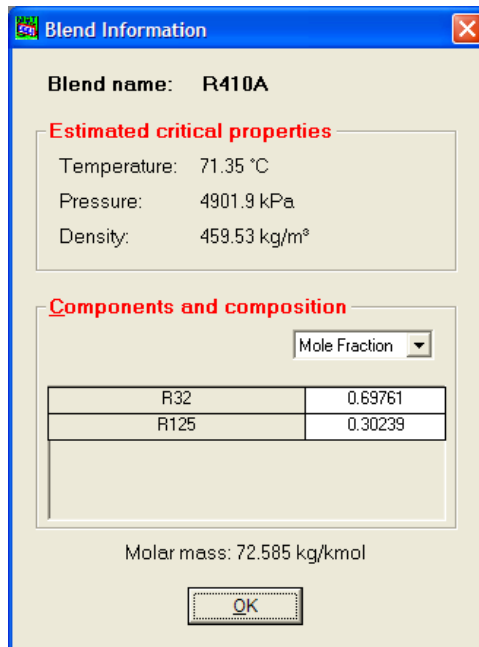

Figure 7. Information for a predefined blend

For the **Define New Blend** option (Figure 8), refrigerants from the left-hand list can be added to the mixture (right-hand list) via the **Add** button. Refrigerants can be deleted from the mixture by using the **Remove** button. After specifying the mixture and clicking **OK**, Figure 9 appears. The composition can be modified by typing the appropriate values in the boxes and clicking **OK**. The composition can be specified in terms of mass fractions or mole fractions by toggling the combo box. Note: the mass and mole fractions must sum to unity; if they do not, an error message will appear. The new mixture can be stored by clicking the **Store** button. If the mixture is stored in the “~\mixtures” subdirectory, it will thereafter appear in the list of predefined mixtures (Figure 6).

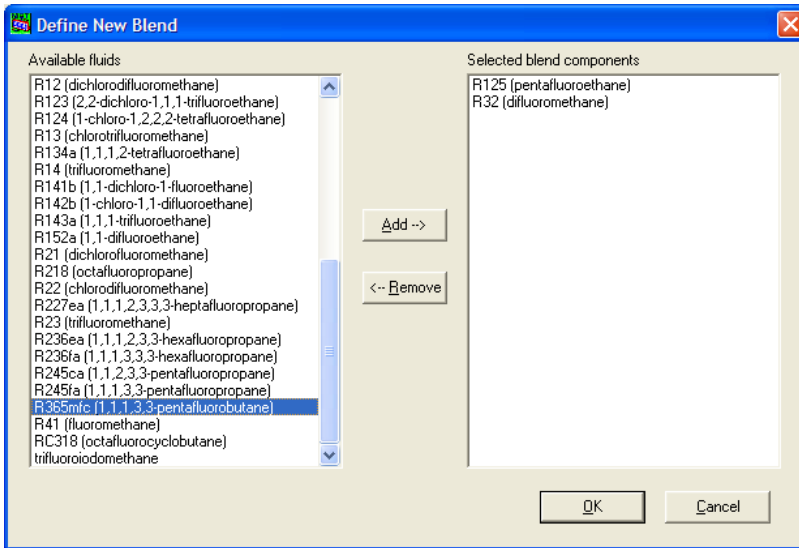

Figure 8. Defining a new blend

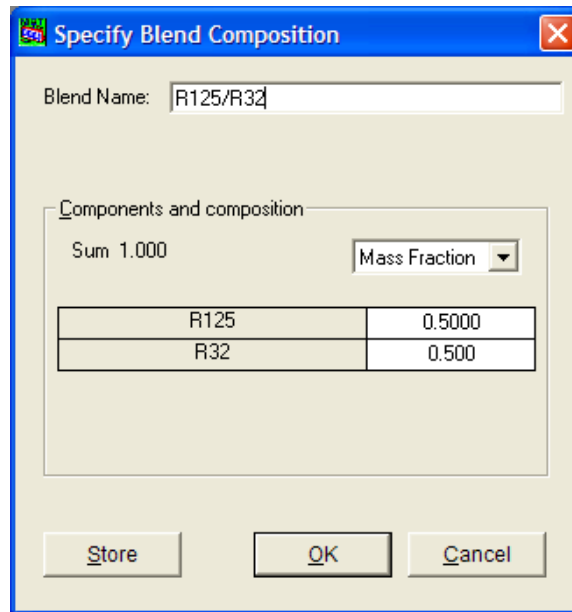

Figure 9. Specifying the new blend composition

Cycle Options Tab

The **Cycle Options** tab presents the following cycle choices (Figure 10):

- Single-stage cycle with or without a LLSL-HX
- Two-stage cycle with an economizer, which includes an option to optimize the intermediate pressure
- Two-stage cycle with an intercooler
- Three-stage cycle with an economizer.

In the example shown in Figure 10, we selected the single-stage cycle with the LLSL-HX of 50 % effectiveness.

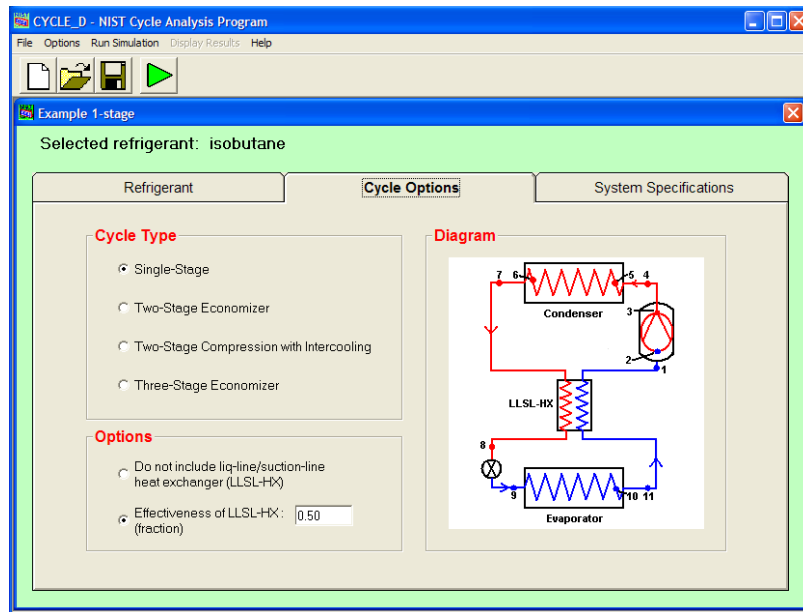

Figure 10. Cycle Options tab

For two-stage economizer cycles, click the **Two-Stage Economizer** radio button and either the **Impose intermediate pressure** radial button or the **Optimize intermediate pressure** radial button; the **Cycle Options** tab will display these two options after the **Two-Stage Economizer** option has been selected.

For two-stage compression with intercooling cycles, click the **Two-Stage Compression with Intercooling** radial button and then input the **Intermediate pressure**.

For three-stage economizer cycles, click the **Three-Stage Economizer** radial button and then input the **Intermediate pressure for high-pressure stage** and the **Intermediate pressure for low-pressure stage**.

System Specifications Tab

The set of data required for the system specification depends on the simulated cycle type. Figure 11 presents the specification input for a single-stage system operating in a subcritical regime. In this example, we specify the compressor by inputting the compressor isentropic efficiency, compressor volumetric efficiency, and compressor electric motor efficiency, all expressed in fractions. The right-hand-side column includes the net system **Cooling Capacity**, **Vapor Line Pressure Drop** in terms of a drop of dew-point temperature, and **Auxiliary Power** input.

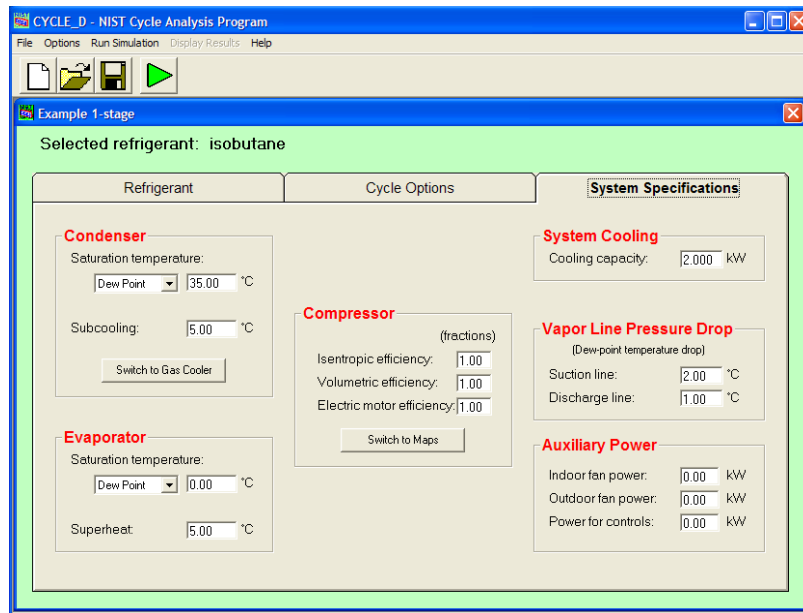

Figure 11. System Specifications tab for a single-stage, subcritical cycle and efficiency-based representation of the compressor

The options shown in Figure 11 for a gas cooler (transcritical cycle) and compressor maps are not available for other than the single-stage, subcritical cycle selected in this example. On the other hand, for multi-stage cycles the **System Specifications** tab will solicit input for intermediate pressure(s), which is not applicable to the single-stage system.

Using a Compressor Map

When the **Switch to Maps** key is clicked, the **System Specifications** window will allow the user to select a compressor from the pull-down menu located in the **Compressor** box, as shown in Figure 12. Once a compressor is chosen, the user needs to select either the system **Cooling Capacity** or **Capacity Multiplier** option. For simulating a system with a capacity provided by the selected compressor, input the value 1 in the **Capacity Multiplier** input box.

Appendix C explains how to input a new or modify an existing compressor map.

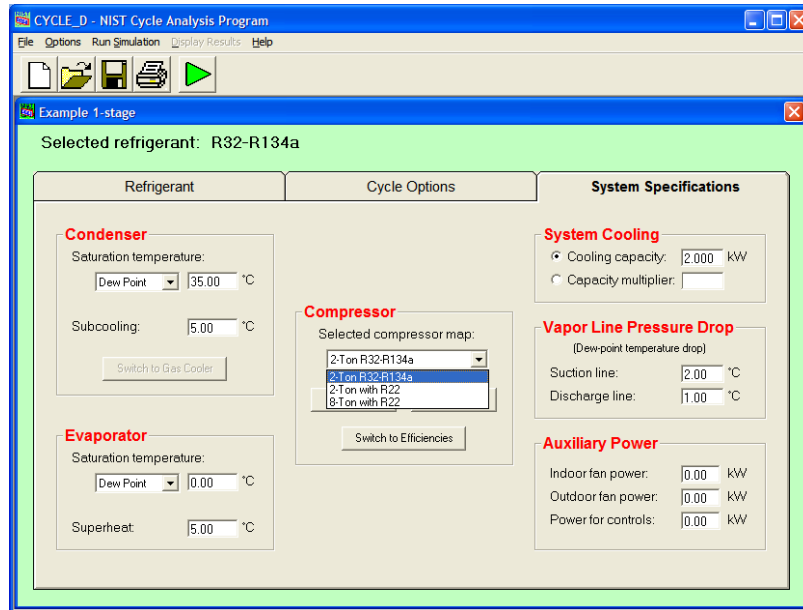

Figure 12. System Specifications tab for a single-stage, subcritical cycle and map-based representation of the compressor

Entering Data for the Transcritical Cycle

If the high-side pressure exceeds the critical pressure of the refrigerant, the high-side heat exchanger will operate as a gas cooler. To input data for the gas cooler, click the **Switch to Gas Cooler** key; a box will appear for specifying the refrigerant temperature at the gas cooler outlet, and the option to specify the high-side pressure or to have it optimized by CYCLE_D (Figure 13). Simulating a transcritical cycle is available only for single-stage systems using the efficiency-based compressor representation.

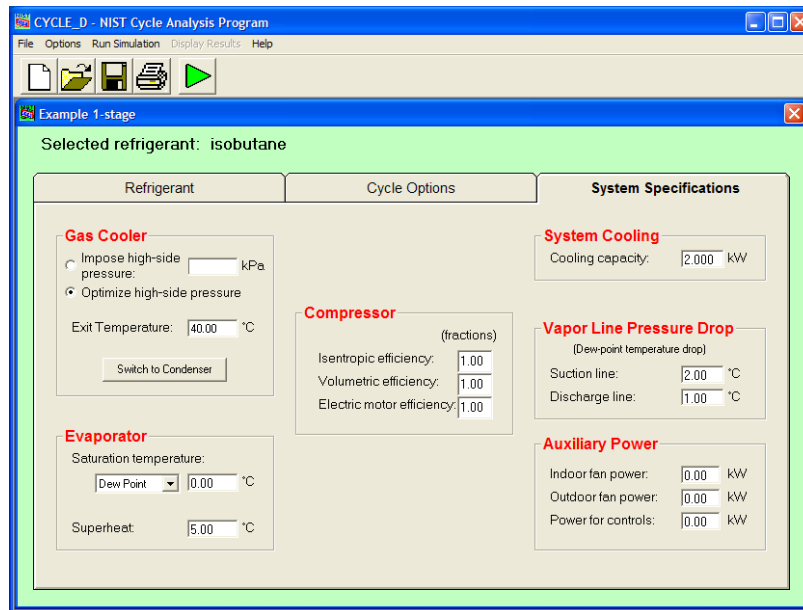

Figure 13. System Specifications tab for a single-stage, transcritical cycle and optimization option selected for the gas cooler pressure

Loading an Existing File with Input Data

Rather than entering data, the user may opt to open a previously stored input data file and modify it. To open an existing file click on the **File/Open** menu item, or click the **Open File** button on the power bar. A window shown in Figure 14 will appear. Standard Windows steps are applicable for opening and storing files. After a file is selected and opened, the user should modify the input using different tabs, as explained in the previous section for inputting new data.

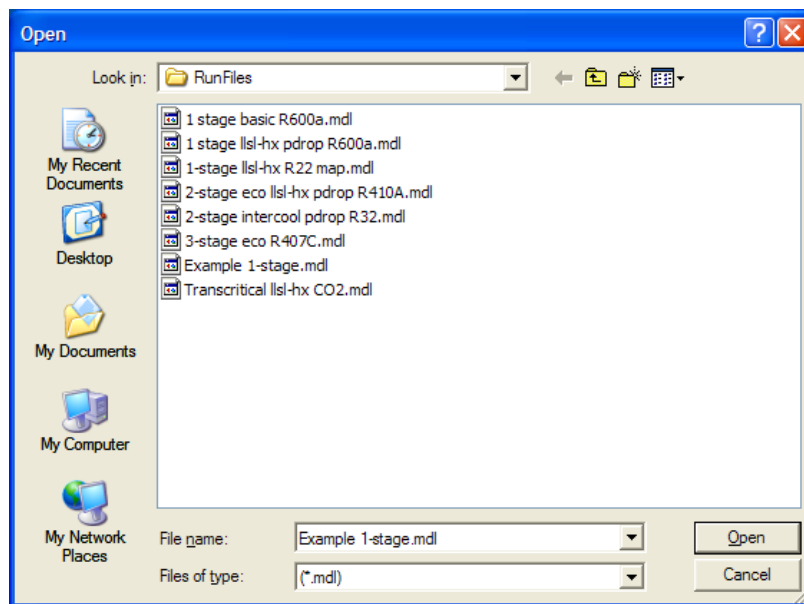

Figure 14. Opening a previously stored input data file

Executing a Simulation Run

To execute a simulation run, use the **Run Simulation** pull down menu or click on the **Run Simulation** key (the green arrow located on the power bar). The program will first perform various checks to ensure that the input data are valid, and then will proceed with the simulation calculations.

Presenting Simulation Results

Summary Results

When the simulation is complete, the **Summary Results** window will appear. The corresponding windows showing system schematic thermodynamic diagrams and LLSL-HX information can be displayed by using either the **Display Results** pulldown menu or the four buttons located on the right-hand side of the power bar. Figure 15 shows a tile with the results windows. The window in the front presents Summary Results for the input data shown in Figures 10 and 11. This data set is also contained in the file **Example 1-stage.mdl**, which the **CYCLE_D** installation module places in the **RunFiles** subfolder.

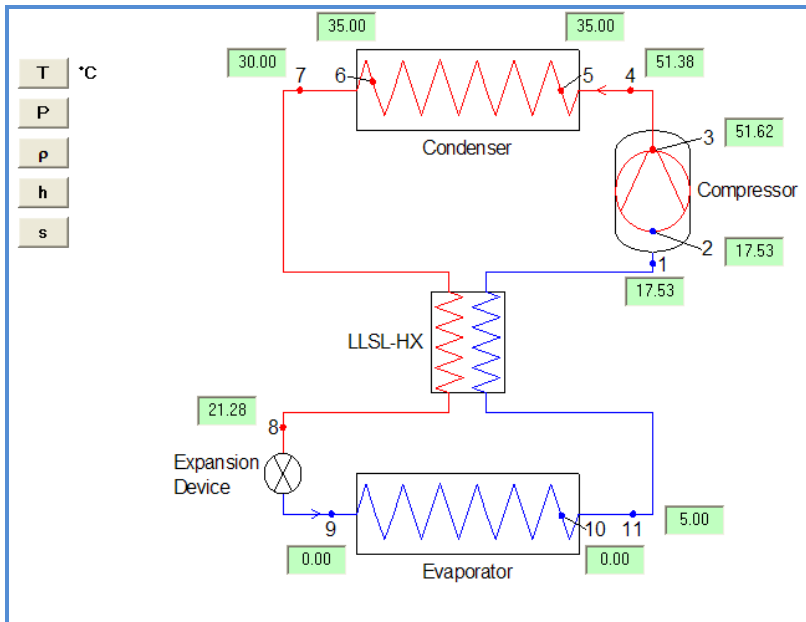

Figure 16. System schematic window

State Diagram Windows

Figure 17 shows an example **P-h State Diagram** and Figure 18 shows an example **T-s State Diagram** corresponding to the input data shown in Figures 10 and 11. The minimum and maximum tick marks were modified for both figures within CYCLE_D program. To modify (1) the axis labels, (2) the minimum, maximum, and intervals between major tick marks, (3) the font sizes, (4) the number formatting, (5) the presence or non-presence of gridlines, (6) the specification of the axes in linear or logarithmic scales, and/or (7) the line/symbol type and color for the saturated liquid line, saturated vapor line, or process lines, double-click on the desired figure, after which Figure 19 appears. Note: the **P-h State Diagram** and the **T-s State Diagram** have to be modified independently of one another.

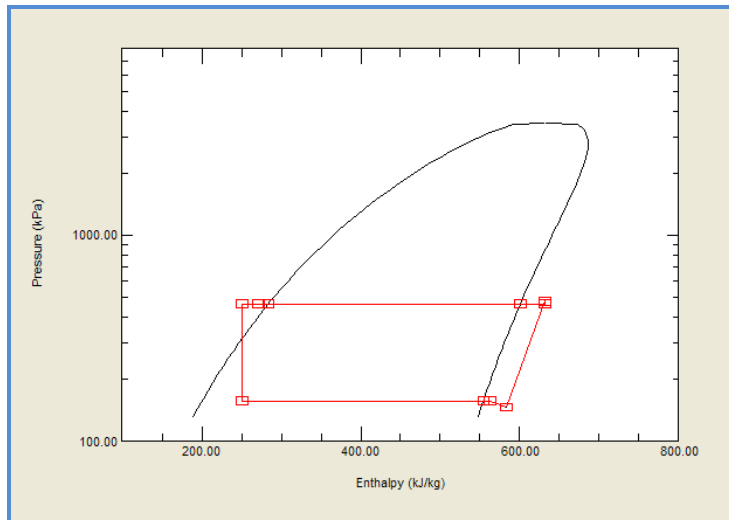

Figure 16. P-h state diagram

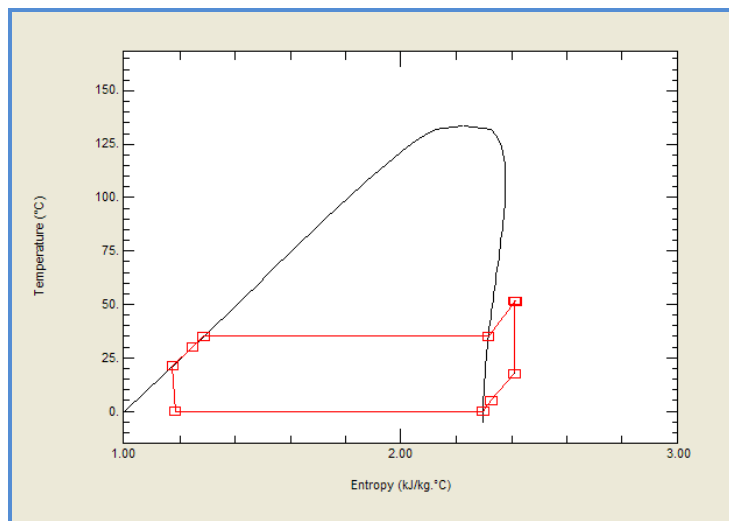

Figure 17. T-s state diagram

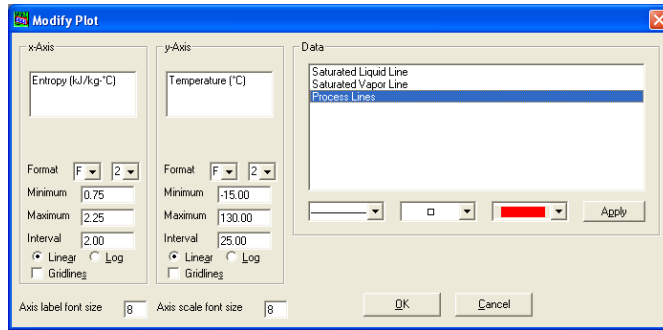

Figure 18. Modifying the P-h or T-s state diagram

Line Sizing Information

Figure 19 shows the content of the **Line Sizing Information** window corresponding to the input data shown in Figures 10 and 11.

Outside Diameter (mm)	Length Suction line (m)	Vapor Velocity (m/min)	Length Discharge line (m)	Vapor Velocity (m/min)	Length Liquid line (m)	Liquid Velocity (m/min)
9.520	(1)	1.835E+03	8.268E+00	6.675E+02	9.284E+02	1.403E+01
12.700	(1)	9.846E+02	3.670E+01	3.583E+02	4.005E+03	7.532E+00
15.880	(1)	6.130E+02	1.140E+02	2.230E+02	1.216E+04	4.689E+00
19.050	(1)	4.106E+02	2.969E+02	1.494E+02	3.102E+04	3.141E+00
22.220	(1)	2.953E+02	6.520E+02	1.074E+02	6.691E+04	2.259E+00
28.580	(1)	1.732E+02	2.328E+03	6.300E+01	2.316E+05	1.325E+00
34.920	(1)	1.138E+02	6.322E+03	4.141E+01	9.296E+05	8.706E-01
41.280	(1)	8.029E+01	1.449E+04	2.922E+01	1.868E+06	6.142E-01
53.980	(1)	4.619E+01	5.386E+04	1.681E+01	5.644E+06	3.533E-01
66.680	(1)	2.994E+01	1.504E+05	1.090E+01	1.343E+07	2.291E-01
79.380	(1)	2.099E+01	3.490E+05	7.636E+00	2.734E+07	1.605E-01
92.080	(1)	1.551E+01	7.129E+05	5.644E+00	5.003E+07	1.187E-01
104.780	(1)	1.193E+01	1.325E+06	4.341E+00	8.457E+07	9.128E-02
130.180	(1)	7.658E+00	3.768E+06	2.787E+00	2.053E+08	5.859E-02
155.580	(1)	5.327E+00	8.854E+06	1.938E+00	4.243E+08	4.075E-02
206.380	(1)	3.050E+00	3.282E+07	1.110E+00	1.295E+09	2.333E-02
257.180	(1)	1.964E+00	9.194E+07	7.148E-01	3.120E+09	1.503E-02
307.980	(1)	1.361E+00	2.169E+08	4.951E-01	6.504E+09	1.041E-02

Refrigerant line length and velocity values are for straight type L tubing for the refrigerant mass flow rate and pressure drops used in the cycle simulation. that would result in bringing the subcooled refrigerant to flashing.

Refrigerant mass flow rate: 23.0 kg/h

Pressure drops

Suction line: 10.8 kPa

Discharge line: 12.8 kPa

Liquid line: 60.0 kPa

(1) - Calculations are not provided for a non-adiabatic suction line (liquid line/suction line heat exchanger).

Figure 19. Line sizing information

Saving Input Data

To save the current input data set, use either the **Save** button located on the power bar or one of the options available under the **File** menu item.

Diagnostic Messages

CYCLE_D provides stable solutions if the specified cycle operating conditions do not extend beyond the range for which REFPROP 8.0 [1] property routines were validated for a particular working fluid (pure refrigerant or refrigerant mixture). If CYCLE_D encounters problems during a cycle simulation, it will write diagnostic messages in the file ERREF.TXT located in the default folder. In such a case, the interface will display a note that the messages were written and will provide the option to read them. Note that refrigerant property routines can become unstable in the neighborhood of the critical point.

Help Menu

Click on the **Help** menu item to access online help. The help file consists of two tabs: **Index** and **Search**. The **Index** tab contains detailed help topics arranged alphabetically. The **Search** tab allows the user to search the contents using keywords. Figure 20 shows a list of help topics in the **Index** tab.

Cycle Options
Compressor Map
New Compressor Map
Single-Stage
Three-Stage Economizer
Two-Stage Compression with Intercooling
Two-Stage Economizer
Errors
Input Data Conflicts
Input Data Out of Range
Non Numeric Input Data
Specification of Mass (or Mole) Fractions
File
Exit
New
Open
Print Setup
Save
Save As
Save As Default File
Help
Modify State Diagrams
Axis Labels
Axis Labels Font Size
Axis Scale Font Size
Format
Gridlines
Interval
Linear
Log
Maximum
Minimum
Process Lines
Saturated Liquid Line
Saturated Vapor Line
Options
Reference State
Startup Preferences
Opening Window
Units
Refrigerant
Define New Blend
Predefined Blend
Blend Information
Single-Compound Fluid
Fluid Information
Results
Display Results
Line Sizing Information
P-h State Diagram
Schematic Diagram
Summary Results
T-s State Diagram
System Specifications

Figure 20. List of help topics in the Help Index tab

REFERENCES

- [1] Eric W. Lemmon, Marcia L. Huber, Mark O. McLinden, 2007, NIST Reference Fluids Thermodynamic Properties - REFPROP, Ver. 8.0, NIST Standard Reference Database 23, National Institute of Standards and Technology, Gaithersburg, Maryland, U.S.A.
<http://www.nist.gov/srd/nist23.htm>.
- [2] Performance Rating of Positive Displacement Refrigerant Compressors and Compressor Units, Standard ANSI/ARI 540-2004, Air-Conditioning and Refrigeration Institute, Arlington, VA, 2004,
http://www.ahrinet.org/Content/FindaStandard_218.aspx.

Appendix A

SINGLE-COMPOUND REFRIGERANTS AVAILABLE IN CYCLE_D

Short Name	Full Chemical Name	T _{crit} (°C)	T _{crit} (°F)
R-11	trichlorofluoromethane	198.0	388.3
R-12	dichlorodifluoromethane	112.0	233.6
R-13	chlorotrifluoromethane	29.2	84.6
R-1311	trifluoroiodomethane	123.3	253.9
R-14	tetrafluoromethane	-45.6	-50.2
R-21	dichlorofluoromethane	178.3	353.0
R-22	chlorodifluoromethane	96.2	205.1
R-23	trifluoromethane	25.9	78.7
R-32	difluoromethane	78.1	172.6
R-41	fluoromethane	44.1	111.4
R-50	methane	-116.7	-82.7
R-113	1,1,2-trichloro-1,2,2-trifluoroethane	214.1	417.3
R-114	1,2-dichloro-1,1,2,2-tetrafluoroethane	145.7	294.2
R-115	chloropentafluoroethane	80.0	175.9
R-116	hexafluoroethane	19.9	67.8
R-123	1,1-dichloro-2,2,2-trifluoroethane	183.7	362.6
R-124	1-chloro-1,2,2,2-tetrafluoroethane	122.3	252.1
R-125	pentafluoroethane	66.2	151.1
R-134a	1,1,1,2-tetrafluoroethane	101.1	213.9
R-141b	1,1-dichloro-1-fluoroethane	204.2	399.6
R-142b	1-chloro-1,1-difluoroethane	137.1	278.8
R-143a	1,1,1-trifluoroethane	72.9	163.2
R-152a	1,1-difluoroethane	113.3	235.9
R-170	ethane	32.2	89.9
R-218	octafluoropropane	161.5	72.0
R-227ea	1,1,1,2,3,3,3-heptafluoropropane	102.8	217.0
R-236ea	1,1,1,2,3,3-hexafluoropropane	139.3	282.7
R-236fa	1,1,1,3,3,3-hexafluoropropane	124.9	256.9
R-245ca	1,1,2,2,3-pentafluoropropane	174.4	346.0
R-245fa	1,1,1,3,3-pentafluoropropane	154.1	309.3
R-365mfc	1,1,1,3,3-pentafluorobutane	186.9	368.3
R-290	propane	96.7	206.1
R-C318	octafluorocyclobutane	115.2	239.4
R-600	butane	152.0	305.6
R-600a	isobutane or 2-methylpropane	134.7	274.5
R-717	ammonia	132.3	270.1
R-718	water	374.0	705.1
R-744	carbon dioxide	31.1	87.9
R-1150	ethylene	9.2	48.6
R-1270	propylene or propene	92.4	198.4
R-E170	dimethylether or ethylene oxide	127.2	260.9
CH3CH2CH=CH2	1-butene	146.1	295.1
Cyclo-C3H6	cyclopropane	125.2	257.3
C2H6O	ethanol or ethyl alcohol	240.8	465.4

CYCLE_D 26

CH(CH ₃) ₃	isobutene or 2-methyl-1-propene	144.9	292.9
(CH ₃) ₂ CH(CH ₂) ₂ CH ₃	isohexane or 2-methylpentane	224.6	436.2
(CH ₃) ₂ CHCH ₂ CH ₃	isopentane or 2-methylbutane	187.2	369.0
CH ₃ OH	methanol	239.5	463.0
CH ₃ -3(CH ₂)-CH ₃	pentane	196.6	385.8

CYCLE_D 27

Appendix B

PREDEFINED REFRIGERANT BLENDS AVAILABLE IN CYCLE_D

ASHRAE Designation	Composition Components	(mass %)	T _{crit} (°C)	T _{crit} (°F)
R-401A	R-22/152a/124	53/13/34	107.3	225.2
R-401B	R-22/152a/124	61/11/28	105.6	222.0
R-401C	R-22/152a/124	33/15/52	117.9	233.1
R-402A	R-125/290/22	60/2/38	75.8	168.5
R-402B	R-125/290/22	38/2/60	82.9	181.2
R-403A	R-290/22/218	5/75/20	87.0	188.6
R-403B	R-290/22/218	5/56/39	79.6	175.4
R-404A	R-125/143a/134a	44/52/4	72.1	161.7
R-405A	R-22/152a/142b/C318	45/7/5.5/42.5	106.1	223.1
R-406A	R-22/600a/142b	55/4/41	116.9	242.3
R-407A	R-32/125/134a	20/40/40	82.3	180.1
R-407B	R-32/125/134a	10/70/20	75.0	166.9
R-407C	R-32/125/134a	23/25/52	86.0	186.9
R-407D	R-32/125/134a	15/15/70	91.4	196.5
R-407E	R-32/125/134a	25/15/60	88.5	191.2
R-408A	R-125/143a/22	7/46/47	83.1	181.7
R-409A	R-22/124/142b	60/25/15	109.3	228.7
R-409B	R-22/124/142b	65/25/10	106.9	224.5
R-410A	R-32/125	50/50	71.4	160.4
R-410B	R-32/125	45/55	70.8	159.5
R-411A	R-1270/22/152a	1.5/87.5/11.0	99.1	210.4
R-411B	R-1270/22/152a	3/94/3	95.9	204.7
R-412A	R-22/218/142b	70/5/25	107.2	224.9
R-413A	R-218/143a/600a	9/88/3	96.6	205.8
R-414A	R-22/124/600a/142b	51/28.5/4/16.5	112.7	234.8
R-414B	R-22/124/600a/142b	50/39/1.5/9.5	111.0	231.8
R-415A	R-22/152a	82/18	102.0	215.5
R-415B	R-22/152a	25/75	111.4	232.5
R-416A	R-124/R134a/600	39.5/59.0/1.5	107.1	224.8
R-417A	R-125/134a/600	46.6/50.0/3.4	87.1	188.9
R-418A	R-290/22/152a	1.5/96/2.5	96.2	205.2
R-419A	R-125/134a/E170	77/19/4	82.1	179.7
R-420A	R-134a/142b	88/12	104.8	220.6
R-421A	R-125/134a	58/42	82.8	181.0
R-421B	R-125/134a	85/15	72.4	162.3
R-422A	R-125/134a/600a	85.1/11.5/3.4	71.7	161.1
R-422B	R-125/134a/600a	55/24/3	83.2	181.8
R-422C	R-125/134a/600a	82/15/3	73.1	163.5
R-422D	R-125/134a/600a	65.1/31.5/3.4	79.6	175.2
R-423A	R-134a/227ea	2.5/47.5	99.1	210.5
R-424A	R-125/134a/600a/600/isopentane	50.5/47/0.9/1/0.6	85.9	186.6
R-425A	R-32/134a/227ea	18.5/69.5/12	93.9	201.0
R-426A	R-125/134a/600/isopentane	5.1/93/1.3/0.6	99.8	211.7

CYCLE_D 28

R-427A	R-32/125/143a/134a	15/25/10/50	85.3	185.6
R-428A	R-125/143a/290/600a	77.5/20/0.6/1.9	69.0	156.2
R-500	R-12/152a	73.8/26.2	102.1	215.8
R-501	R-22/12	75/25	95.9	204.6
R-502	R-22/115	48.8/51.2	81.5	178.7
R-503	R-23/13	40.1/59.9	18.4	65.1
R-504	R-32/115	48.2/51.8	62.1	143.9
R-507A	R-125/143a	50/50	70.6	159.1
R-508A	R-23/116	39/61	10.2	50.3
R-508B	R-23/116	46/54	11.2	52.2
R-509A	R-22/218	44/56	68.4	155.2

CYCLE_D 29

Appendix C

COMPRESSOR MAPS

Compressor Map Formats

CYCLE_D uses three types of compressor maps for representing the compressor performance. Their format is give below.

Compressor map # 1 (based on the ANSI/ARI Standard 540 [2])

$$X = B1 + B2 \cdot T_s + B3 \cdot T_d + B4 \cdot T_s^2 + B5 \cdot T_s \cdot T_d + B6 \cdot T_d^2 + B7 \cdot T_s^3 + B8 \cdot T_d \cdot T_s^2 + B9 \cdot T_s \cdot T_d^2 + B10 \cdot T_d^3$$

where

- B1-B10 = correlation coefficients
- T_s = compressor suction dew-point temperature, °C (°F)
- T_d = compressor discharge dew-point temperature, °C (°F)
- X = represents (as designated): refrigerant mass flow rate, kg/s (lb/h) or power input W, (W)

Compressor map # 2 (pressure-based correlation)

$$X = B1 + B2 \cdot P_d + B3 \cdot P_s + B4 \cdot P_d^{0.9} + B5 \cdot P_s^{0.89} + B6 \cdot P_s \cdot P_d$$

where

- B1-B6 = correlation coefficients
- P_s = suction pressure, kPa (psia)
- P_d = discharge pressure, kPa (psia)
- X = represents (as designated): cooling capacity, W (Btu/h) or power input W

Compressor map # 3 (modified temperature-based correlation)

$$X = B1 + B2 \cdot T_d + B3 \cdot T_d^2 + B4 \cdot T_s + B5 \cdot T_s \cdot T_d + B6 \cdot T_s \cdot T_d^2 + B7 \cdot T_s^2 + B8 \cdot T_d \cdot T_s^2 + B9 \cdot T_s^2 \cdot T_d^2$$

where

- B1-B9 = correlation coefficients
- T_s = compressor suction dew-point temperature, °C (°F)
- T_d = compressor discharge dew-point temperature, °C (°F)
- X = represents (as designated): cooling capacity, W (Btu/h) or power input kW

CYCLE_D 30

Preparing a New Compressor Map

In the **System Specifications** tab, click the **Switch to Maps** key, and then click the **Create New** key shown in Figure C1.

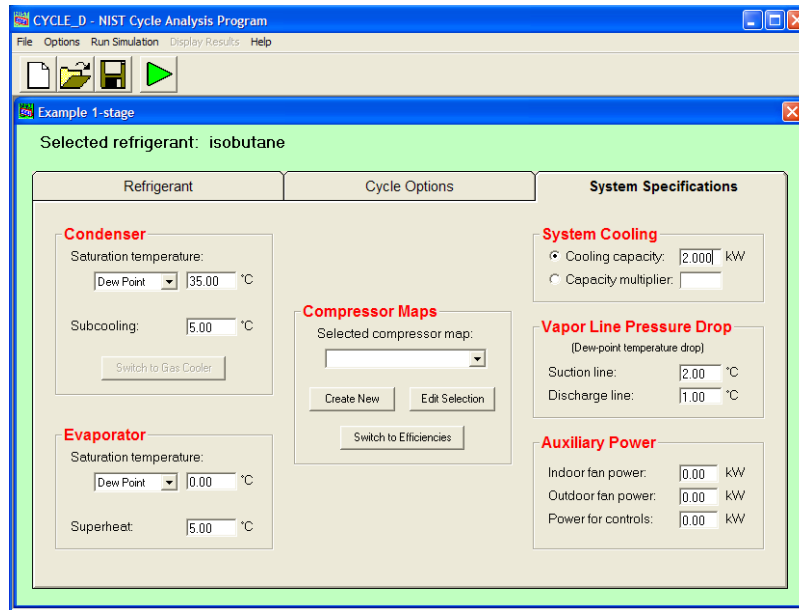

Figure C1. **System Specifications** tab showing the **Create New** and **Edit Selection** compressor map options after a click on the **Switch to Maps** key

Click the **Create New** to have the input window displayed for compressor maps (Figure C2). The window has radio buttons for selecting one of the three compressor maps and their units. The units selected in the window are applicable to the compressor map output, coefficients and temperature unit for which the coefficients were developed. This unit selection does not override the units the user selected outside of this window for the input data and output of simulation results.

The refrigerant selection in this window will override the prior selection of the refrigerant within the **Refrigerant** tab (Figure 1). The refrigerants available for selection in this window are those available within the **Refrigerant** tab as **Single-Compound Fluid** or

Predefined Blend. If the compressor uses a blend that is not available, the user needs to define this blend first using the **Define New Blend** (Figure 1) key before inputting compressor coefficients.

Compressor Data

File Name:

Compressor Description:

Compressor Map

ANSI/ARI Standard 540-2004
 Pressure-based
 Modified temperature-based

Units

SI IP

Note: No conversion is available between SI and I-P units for compressor data.

Coefficient	Power Input (kW)	Refrigerant mass flow rate (kg/s)
1	<input type="text"/>	<input type="text"/>
2	<input type="text"/>	<input type="text"/>
3	<input type="text"/>	<input type="text"/>
4	<input type="text"/>	<input type="text"/>
5	<input type="text"/>	<input type="text"/>
6	<input type="text"/>	<input type="text"/>
7	<input type="text"/>	<input type="text"/>
8	<input type="text"/>	<input type="text"/>
9	<input type="text"/>	<input type="text"/>
10	<input type="text"/>	<input type="text"/>

Suction superheat: °C

Condenser subcooling: °C

Refrigerant:

Print OK Cancel

Figure C2. Input data window for compressor map data (ANSI/ARI Standard 540-2004 map selected)

Appendix D

NOMENCLATURE USED FOR REPORTING SIMULATION RESULTS

This appendix presents the symbol convention used for simulation results in the order they appear on the printout. Self-explanatory output is omitted here. Note that the printout varies somewhat between simulation options.

Thermodynamic Cycle Results

T	= temperature
P	= pressure
h	= specific enthalpy
v	= specific volume
s	= specific entropy
XQ	= mass-based quality
Work	= specific work of compression
Qevap	= specific evaporator capacity
Qcond	= specific condenser capacity
COPc	= coefficient of performance in the cooling mode
COPh	= coefficient of performance in the heating mode
Two-phase glide, evaporator	= temperature difference between saturated vapor and evaporator inlet
Two-phase glide, condenser	= temperature difference between saturated vapor and saturated liquid
Condenser superheat	= temperature difference between condenser inlet and saturated vapor
P(3)/P(2)	= compression pressure ratio
Volumetric capacity, cooling	= $Q_{evap}/v(2)$
Volumetric capacity, heating	= $Q_{cond}/v(2)$

Compressor and System Results

m^3/h or cfm	= compressor volumetric output
$m^3/h/kW$ or cfm/ton	= (compressor volumetric output) / (cooling capacity of evaporator) {1 ton = 12000 Btu/h}
Total power	= sum of powers of compressor, indoor fan, outdoor fan, and controls
COPc,sys	= (system cooling capacity)/(total power)
COPh,sys	= (system heating capacity)/(total power)

Appendix E

UNITS, CHECKS AND WARNINGS

There are a number of built-in checks and warnings in CYCLE_D. Efforts have been made in developing the system to make the checks self-explanatory. Presented below are: (1) an explanation of consistency in units and (2) some examples of the run time checks and warnings.

(1) Systems of Units

Users may select either I-P or SI units.

I-P Units:

By selecting "I-P units," **temperatures** are entered in °F.

SI Units:

By selecting "SI units," **temperatures** are entered in °C (**SI – Celsius** option) or K (**SI – Kelvin** option).

Common Bases:

In both systems, mass composition and efficiency values are entered as decimals not greater than unity. (**Note, decimals, not percent**)

(2) Checks and Warnings

The following are examples of checks and warnings built into the CYCLE_D system:

1. In selecting the number of refrigerants in a new mixture, the number must be from 2 to 5.
2. If the sum of refrigerant mass (or mole) fractions is greater than unity, an error message is issued.
3. Compressor isentropic efficiency values must be greater than or equal to 0.05 and less than or equal to unity.
4. Compressor volumetric efficiency values must be greater than or equal to 0.05 and less than or equal to unity.

5. Compressor motor efficiency values must be greater than or equal to 0.05 and less than or equal to unity.
6. The suction line dew-point temperature loss must be less than the refrigerant critical temperature.
7. The discharge line bubble-point temperature loss must be less than the refrigerant critical temperature.
8. The bubble-point temperature of refrigerant in the condenser must be greater than the dew-point temperature of refrigerant in the evaporator.
9. The condenser temperature must be greater than the evaporator temperature.
10. The condenser temperature must be less than the refrigerant critical temperature.
11. The gas cooler refrigerant pressure must be greater than the critical pressure.
12. The intermediate pressures for the two-stage economizer cycle, the two-stage compression with intercooling cycle, and the three-stage economizer cycle must fall between the evaporator and condenser pressures.
13. For the three-stage economizer cycle, the intermediate pressure of the low-pressure stage must be below the intermediate pressure of the high-pressure stage.

Appendix F

CONTACTS

If you have comments or questions about the database, the Standard Reference Data Program would like to hear from you. Also, if you should have any problems with the CDs or installation, please let us know by contacting:

Joan Sauerwein
National Institute of Standards and Technology
Standard Reference Data Program
100 Bureau Drive, Stop 2310
Gaithersburg, MD 20899-2310
Phone: (301) 975-2208
Fax: (301) 926-0416
Website: <http://www.nist.gov/srd>

If you have questions or problems pertaining to the use of CYCLE_D, contact:

Piotr A. Domanski
National Institute of Standards and Technology
Building and Fire Research Laboratory
100 Bureau Drive, Stop 8631
Gaithersburg, MD 20899-8631
e-mail: piotr.domanski@nist.gov