

Modeling and Monitoring of Construction Supply Chains

Jack C.P. Cheng ^a, Kincho H. Law ^a, Hans Bjornsson ^b, Albert Jones ^c, Ram D. Sriram ^c
cpcheng@stanford.edu, law@stanford.edu, hansbj@stanford.edu, albert.jones@nist.gov, sriram@nist.gov

^a Engineering Informatics Group, Department of Civil and Environmental Engineering, Stanford University

Address: Y2E2 Building, Department of Civil and Environmental Engineering, 473 Via Ortega, Stanford, CA 94305-4020, USA

^b Chalmers University of Technology, Sweden

Address: School of Technology Management and Economics, Chalmers University of Technology, Gothenburg, Sweden

^c Enterprise Systems Group, National Institute of Standards and Technology

Address: 100 Bureau Drive, Stop 8200, Gaithersburg, MD 20899-8200, USA

Corresponding Author: Jack C.P. Cheng

Telephone: 1-650-862-3262

Email Address: cpcheng@stanford.edu; jackcpcheng@gmail.com

Postal Address: Y2E2 Building, Room 279, Department of Civil and Environmental Engineering, 473 Via Ortega, Stanford, CA 94305-4020, USA

Abstract The planning and management of supply chains require properly specifying the participating members and the relationships among them. Construction supply chains usually consist of numerous participants and are complex in structure. Representing construction supply chains using a network model can help understand the complexity, support re-configuration, identify the bottlenecks, and prioritize company's resources, as well as add values to the management of construction projects. Using a case example on the mechanical, electrical and plumbing (MEP) processes in a construction project, this paper demonstrates the modeling of construction supply chains using the Supply Chain Operations Reference (SCOR) framework developed by the Supply Chain Council (SCC). The SCOR modeling framework provides a structured and systematic way to model and decompose a supply chain from conceptual representation to process element specification. The SCOR framework is commonly used by corporations for strategic planning of their supply chains. This paper further presents a model-based service oriented framework that leverages the SCOR models for performance monitoring of construction supply chains. In the supply chain management and monitoring framework each supply chain process element is implemented as discrete Web service components. The framework is built on a service oriented collaborative system, namely SC Collaborator, that we have developed using Web service technology, open standards, and open source technologies.

Keywords Construction Supply Chain, Supply Chain Performance Measurement, Service Oriented Architecture, Model-based Approach, Web Services

1. Introduction

The planning and management of supply chains require properly specifying the participating members and identifying the relationships among them. This task is especially challenging in the construction industry because construction supply chains are complex in structure and often composed of a large number of participants who work together in a project-based temporary manner. Construction projects typically involve tens and hundreds of companies, supplying materials, components, and a wide range of construction services (Dainty et al. 2001). Modeling the structure of participants involved in a construction supply chain can help understand the complexity and the organization in a supply chain (O'Brien et al. 2002). Supply chain network models also facilitate the identification of bottlenecks and provide the basis for supply chain re-configuration and re-engineering.

Standard methods or frameworks for representing and modeling supply chain structures are few. Supply chain structures are commonly recorded as tables that enlist the members of a supply chain, or represented as network diagrams that show the supply chain members as well as the links between them. Lambert and Cooper (2000) proposed a mapping of supply chain structures using three primary attributes: members of the supply chain, structural dimensions, and types of business processes between the members. However, these methods do not provide a direct migration from the modeling of supply chain structures to the modeling of the business operations. There are two commonly used supply chain modeling frameworks that provide guidelines to systematically map the relationships of companies and specify the operations involved in a supply chain. The Supply Chain Model framework introduced by the Global Supply Chain Forum (GSCF) is built on eight key business processes that are both cross-functional and cross-organizational in nature (Lambert 2008). The eight processes are customer

relationship management, supplier relationship management, customer service management, demand management, order fulfillment, product development and commercialization, manufacturing flow management, and returns management. Each process is managed by a cross-functional team, including representatives from logistics, production, purchasing, finance, marketing, and research and development. The Supply Chain Model framework provides a granular framework to model the cross-departmental interactions in every process along a supply chain. However, the majority of construction companies are small and medium enterprises (SMEs) and often do not have a clear boundary between business functional units. According to a study on the construction industry in United Kingdom (Dainty et al. 2001), for example, about 83% of the private contracting companies employ three or less workers while 98% of the companies employ 24 or less workers. Employees in construction companies usually work on a project basis instead of a business functional basis. Therefore, the Supply Chain Model framework that describes the interactions across internal business functional units is not suitable for modeling construction supply chains.

The other framework is the Supply Chain Operations Reference (SCOR) modeling framework established by the Supply Chain Council (SCC) for supply chain standardization, measurement, and improvement (Supply Chain Council (SCC) 2008). The SCOR modeling framework is based on five key supply chain processes – Plan, Source, Make, Deliver, and Return. The SCOR modeling framework is hierarchically structured into four levels, with increasing details at each level. Construction supply chains often do not have a standard and well structured configuration. Members may not be involved in both the material flows and the information flows of the procurement, manufacturing, and distribution activities in construction supply chains. Since the SCOR framework is generic and can be used to model companies of

various types and scales, the framework is suitable for modeling various construction supply chains of different complexity. In this study, therefore, the SCOR framework is employed for modeling construction supply chains.

The SCOR framework is typically used to model supply chain network structures and operations for strategic planning purposes (Huan et al. 2004). The framework is seldom leveraged for the design and implementation of information systems for supply chain management. Furthermore, while performance monitoring is critical to the measurement and improvement of supply chains, there have been little efforts focused on performance monitoring systems for construction supply chain management.

This paper discusses the modeling and decomposition of construction supply chains using the SCOR framework, and describes the development of a supply chain performance monitoring framework that adopts a model-based service oriented approach and leverages the decomposed SCOR models. The supply chain models are developed using a retrospective case study on the mechanical, electrical and plumbing (MEP) processes in a student center construction project. There are altogether 524 distinct process-based performance metrics recommended in SCOR. Since the MEP case example is focused on the procurement and delivery processes, the metrics selected in this study are the process cycle times, documentation accuracy, and product conditions upon arrival. A model-based service oriented approach is adopted in the development of the performance monitoring system. First, the supply chain models are transformed into process execution files by leveraging Business Process Modeling Notation (BPMN) (Object Management Group (OMG) 2008) and Business Process Execution Language (BPEL) (Organization for the Advancement of Structured Information Standards (OASIS) 2007). The execution files are then incorporated in the monitoring system, which is built on an open source

service oriented collaborative system, namely SC Collaborator (Supply Chain Collaborator) (Cheng et al. 2009).

This paper is organized as follows: Section 2 briefly describes the SCOR framework. Section 3 presents the MEP processes in the construction project we studied and illustrates the modeling of the MEP supply chains using the SCOR framework. Section 4 demonstrates the implementation of the prototype supply chain performance monitoring system. Section 4 also discusses the usage of performance metrics and conversion of supply chain models into executable files. Incorporation of the executable files for the business process models in the service oriented system SC Collaborator is illustrated in Section 5. Section 6 shows the system with the construction project example. Section 7 summarizes the research and discusses the limitations, potentials, and future work.

2. Supply Chain Operations Reference (SCOR) Model

The SCOR modeling framework provides a systematic approach to describe, characterize, and evaluate complex supply chain processes. Standardization of business processes is necessary to allow the communication and integration between business partners of the supply network (Gunasekaran et al. 2001). The SCOR model is a process reference model for standardization purposes. The model attempts to capture business operations including (1) customer interactions, from order entry through paid invoice, (2) product transactions, from supplier's supplier to customer's customer, and (3) market interactions, from the understanding of aggregate demand to the fulfillment of each order (Supply Chain Council (SCC) 2008).

The SCOR modeling framework is based on five basic management processes in supply chains – Plan, Source, Make, Deliver, and Return – to meet planned and actual demand (Figure

1). Plan includes processes that balance resources to establish plans that best meet the requirements of a supply chain and its sourcing, production, delivery, and return activities. Source includes processes that manage the procurement, delivery, receipt, and transfer of raw material items, subassemblies, products, and services. Make includes processes that transform products to a finished state. Deliver includes processes that provide finished goods and services, including order management, transportation management, and distribution management. Return includes post-delivery customer support and processes that are associated with returning or receiving returned products.

The SCOR framework allows users to model supply chain structures and relationships in a progressive and systematic manner. There are four levels of model development in the SCOR framework (Figure 2). Level 1 modeling provides a broad definition of the scope and content for the SCOR model (Figure 1). Level 2 modeling divides the five basic management processes into process categories, which allow companies to describe the configuration of their supply chains. Level 2 models conceptually specify the relationship and interactions among supply chain members. The conceptual specification can be extended to describe the process workflow through Level 3 modeling. Level 3 modeling provides companies with the information for detailed planning and setting goals. Level 3 processes also provide the basis for defining the supply chain performance metrics. Level 4 modeling focuses on implementation. Since SCOR Level 4 models are unique to each company, the specific elements at this level are not defined within the SCOR framework. In Level 4 modeling, users need to design the implementation details of each Level 3 process to meet their own needs. Through the four levels of development, the SCOR models can be extended to capture and represent complex interactions among supply chain partners. Therefore, the model is a useful tool for modeling construction

supply chains, which usually involve numerous organizations and are complex in nature. The application of the SCOR framework to model construction supply chains is illustrated in the next section.

3. Modeling of Construction Supply Chains Using SCOR Framework: A Case Example

In this paper, a construction project of a two-storey high school student center is used as a case example (Figure 3). Specifically, the mechanical, electrical and plumbing (MEP) supply chains of the project have been studied retrospectively and modeled based on the information from the documents provided by and the interviews conducted with the general contractor, subcontractors, and suppliers. The buyer-supplier relationships in a construction project can differ from project to project, organization to organization, and product to product. However, similar patterns are observed in the buyer-supplier interactions and configuration of supply chains among various organizations and products in the MEP processes of the project. Although the supply chain modeling is demonstrated only with the MEP supply chains, the framework can be potentially applied and extended to other kinds of supply chains in construction projects of various scales and types.

3.1 Case Example

The student center in the example construction project is a two-storey building with a 650 fixed-seat auditorium, a 350 seat dining hall with a full commercial kitchen and server, three bathrooms, and eight sophisticated science classrooms. The construction project started in May 2008 and was planned to finish by December 2009. To minimize the impact of the construction on student activities on campus, the construction site was kept to minimal. The stocking space

on site was limited in size and needed to change locations occasionally over the project time. Early delivery of materials leading to long-time stocking was not recommended in order to free up the construction site space and to avoid double material handling. Therefore, the general contractor heavily emphasized Just-in-Time material delivery in the project.

There are 170 tasks in the project, and 47 of them are on the critical path. Since many MEP activities are essential for enabling other critical tasks, the MEP activities are usually on the critical path. For example, as shown in Figure 4, the MEP activities for the assembly hall on Level 1, the classrooms on Level 2, and the bathroom on Level 2 are on the critical path. In addition, MEP activities are interior work and often start at the late stage of the project. Therefore, there is little schedule buffer for problems in the MEP activities. The performance and timeliness of the MEP components delivery are important to the on-schedule project delivery. In fact, the project once experienced a serious potential for prolonging project completion time due to the material delays of several electrical products.

Managing the MEP supply chains in the project was more challenging than many project participants had anticipated. The MEP components in the project were large in number and supplied by many different companies. In addition, the project is expected to achieve LEED Platinum Certification from the U.S. Green Building Council. Therefore, many of the MEP (especially electrical) components were designed and specified by the architects. Only a small portion of the electrical components are standard products that can be delivered in a short period of time after procurement. The electrical subcontractor and several other subcontractors did not anticipate and were surprised by the complexity of the material supply management in a project of this scale.

3.2 SCOR Level 1 and Level 2 Modeling

[Figure 5](#) shows the major interactions between the MEP subcontractors (buyers) and the suppliers in the project. The flowchart represents a typical material planning, procurement, and delivery management process for various products in construction projects. The interactions start from the selection of suppliers and the request for submittals and quotes. If the owners or architects do not specify the suppliers, the quotes are used by the subcontractors to evaluate and to select the suppliers. The submittals, which normally include shop drawings, product data, samples, manuals, and reports, are then submitted to the engineers through the general contractor for approval. The submittals may be approved as it is, approved with minor revisions needed, undecided with major revisions and resubmission needed, and rejected. For the latter two cases, the subcontractors need to revise the submittals and resubmit them to the engineers. The revision and resubmission process can be iterative and could take weeks to months in the planning phase.

In the material procurement and delivery management phase in the student center construction project, the interactions along the MEP supply chains show three major patterns according to the nature of products. For high-demand standard commodity products such as wires, tubing, bolts, and nuts that subcontractors purchase from distributors (suppliers), the suppliers usually keep stocks of such products to meet anticipated orders. Therefore, the suppliers usually can deliver the products in a short time once they receive the purchase orders. The second type is standard and configurable products that have low turnover rate and/or high inventory cost, for instance, light fixtures and switchgears. Products of this type are produced only after customers' purchase orders are received, or so-called "made-to-order." The third type is products that are specially designed, engineered, and customized by the owners, architects, engineers, or subcontractors. One example is customized ductwork. Close interactions and

collaborations among the subcontractors, the plants, and the suppliers are often required in the design, engineering, sourcing, and delivery processes. In the following subsections, the SCOR Level 1 and Level 2 modeling of the information flows and material flows for these three types of products is illustrated. The supply chain models are then extended to create supply chain process maps with greater details through the SCOR Level 3 and Level 4 modeling in Section 3.3.

3.2.1 Stocked Standard Products

Some standard products such as wires and tubing are maintained in a finished goods state and kept in stocks in suppliers' inventory prior to the receipt of a customer order. These products usually have high demand and low inventory cost. Suppliers procure according to sales forecast, so products are produced before the suppliers receive order. Supply chains of this type are inventory driven. Unsatisfied orders usually become lost sales as alternative suppliers can often be found.

Construction supply chains for stocked standard products involve foremen in the construction site, subcontractors, distributors, and manufacturers. The SCOR Level 1 model and the SCOR Level 2 model for this type of supply chains are shown in Figure 6 and Figure 7 respectively. The dotted lines and the solid lines represent the information flows and the material flows respectively. The information flows start from the subcontractors' headquarters, where purchase orders are sent. There are two alternative material flow paths. Products are often delivered to the construction site at the time designated by the subcontractors. In some cases, subcontractors hope to better control the material delivery time and practice just-in-time

delivery on site. These subcontractors prefer the suppliers first delivering the products to the subcontractors' warehouses and manage the products themselves.

3.2.2 Make-to-order Standard / Configurable Products

Products of this type include products that are built to a specific design and the products that are manufactured, assembled, or configured from standard parts or subassemblies. Suppliers prefer make-to-order due to various reasons. Suppliers of products such as light fixtures usually do not keep stocks of their products because they often publish a wide variety of products in catalogs and it is hard for them to anticipate the demand for each specific design. Moreover, some products such as switchgears have a high inventory cost and depreciation rate, making it risky to keep stock for uncertain anticipated demand. Many suppliers also like to keep the flexibility to slightly configure and customize their products based on the requirements of a particular customer order. For these reasons, manufacture, assembly, or configuration of these make-to-order standard/configurable products begins only after the receipt and validation of a firm customer order.

Similar to the stocked standard products, members of construction supply chains for make-to-order standard/configurable products include foremen in the construction site, subcontractors, distributors, and manufacturers. Figure 8 and Figure 9 show the SCOR Level 1 model and the SCOR Level 2 model respectively for a typical construction supply chain for make-to-order standard/configurable products. Normally, the products can be delivered directly from the manufacturers to either the construction site or the subcontractors' warehouses. On the other hand, procurement directly to manufacturers is not allowed in general. Distributors serve as a middleman between subcontractors and manufacturers, coordinating the procurement,

production, and delivery in the supply chain. Besides the distributors, some subcontractors also communicate actively with their manufacturers to check the production and to schedule the delivery (the communication channels are shown as the information links with asterisks in Figure 9). By communicating directly with the manufacturers, subcontractors can be less vulnerable to supply chain risk because they can notice any material delay or shortage and mitigate the impact at an early stage.

3.2.3 Custom Products

While make-to-order standard/configurable products include standard products built only in response to a customer order or products configured according to a customer order, custom products include products that are designed, developed, and manufactured in response to a specific customer request. HVAC systems and customized ductworks are examples of custom products. While some standardized ducts can be made-to-order or made-to-stock, ductwork systems with special configurations and dimensions need to be designed and engineered before production. Members of supply chains for custom MEP products usually consist of foremen in the construction site, subcontractors, plants, and material suppliers. A plant represents a business unit for the engineering and production of the custom products. A plant can be a third party company, a department of a supplier, or a subsidiary of a subcontractor. Suppliers, plants, and subcontractors collaborate with each other in the negotiation, design, procurement, production, and delivery processes. Architects and engineers who have specialized requirements may also be involved in the negotiation, design, and production processes. Final and detailed design often starts after the receipt and validation of a customer order. Therefore, supply chains of this type of products are driven by customer requirements and specifications and often take a long time to

complete. The SCOR Level 1 model and Level 2 model for a general construction supply chain for custom products are shown in Figure 10 and Figure 11, respectively.

3.3 SCOR Level 3 and Level 4 Modeling

While SCOR Level 2 models provide an overview of the information flows and material flows along a supply chain, SCOR Level 3 and 4 models specify the business processes involved in the supply chain. A Level 3 model links different SCOR Level 3 supply chain processes into a process map whereas a Level 4 model specifies the necessary business operations to implement a particular SCOR Level 3 process. As an example, Figure 12 depicts the SCOR Level 3 model for a typical construction supply chain for stocked standard products. Similarly, SCOR Level 3 models can be constructed for make-to-order standard/configurable products and for custom products. A Level 3 model usually is a complex map of SCOR Level 3 processes, making it difficult to be developed on paper. The complexity of a Level 4 model may vary, but the configuration in a Level 4 model for a particular Level 3 process may change occasionally. Therefore, a user-friendly digital graphical representation should be used to facilitate the creation, modification, and manipulation of the SCOR Level 3 and Level 4 models. Business process modeling notation (BPMN) (Object Management Group (OMG) 2008), supported by several open source and commercial graphical tools, offers such a standard graphical representation for business processes modeling.

3.3.1 Business Process Modeling Notation (BPMN) Models

BPMN (Object Management Group (OMG) 2008) is an Object Management Group (OMG) standard for business process modeling. This graph-oriented modeling language provides a visual modeling notation to specify business processes in a diagram. The primary objective of

BPMN is to bridge the gap between process design and process implementation. BPMN is targeted both as a high level process specification for business users and as a low level process description details for implementers. The business users should be able to easily read and understand a BPMN business process diagram. On the other hand, the process implementer can add further details to a business process diagram in order to represent the process suitable for a physical implementation. As a result, BPMN models can help define process interactions and facilitate communication in the process design and analysis phase. BPMN models can also act as a blueprint for the subsequent implementation.

There are various standards such as IDEF0 (US Air Force 1981) and UML (Object Management Group (OMG) 2005) for process modeling. In this study, BPMN is used for SCOR Level 3 and Level 4 modeling because BPMN models can easily be converted into executable languages such as Business Process Execution Language (BPEL) (Organization for the Advancement of Structured Information Standards (OASIS) 2007). Efforts spent on the development of SCOR Level 3 and Level 4 models in BPMN can thus be leveraged for system execution, which will be demonstrated in Section 4.2. In addition, the modeling in BPMN is made by simple diagrams with a small set of graphical elements. BPMN models can make complex system architecture understandable and facilitate the understanding of the flows and the processes between different organizations. Moreover, BPMN modeling is user-friendly due to the support of several open source and commercial graphical BPMN tools. This research uses an open source BPMN modeling tool developed by Eclipse Foundation, called Eclipse BPMN Modeler (Eclipse Foundation 2008) (Figure 13).

There are four basic categories of elements in BPMN models – flow objects, connecting objects, swimlanes, and artifacts (Figure 14). Flow objects consist of three core elements –

events, gateways, and activities. An event is denoted as a circle and represents something that happens. An event can associate with other elements such as a message envelope or a clock to perform a complex event. Every process has only one start event and one end event. A gateway determines forking and merging of paths depending on the conditions expressed. An activity element can be a task which represents a single unit of work or a sub-process which has its own self-contained sequence flows and start and end events. Connecting objects represent linkages between flow objects, with sequence flows linking flow objects in the same pool and message flows linking flow objects in different pools. Swimlanes consist of pool and lane elements. A pool represents a major participating company in a process, whereas a lane represents a division of a company. Nevertheless, pool and lane elements are interchangeable and different companies can also be separated by lanes in the same pool.

3.3.2 BPMN Model for SCOR Level 3 Modeling

The SCOR Level 3 model for a typical supply chain for stocked standard products shown in Figure 12 can be represented using BPMN (Figure 15). The sourcing activities of distributors, highlighted in Figure 12, are not included in the BPMN representation because it is assumed that there is no backlog and that a subcontractor only procures stocked standard products from the suppliers with sufficient inventory. Therefore, the supply chain from a subcontractor's perspective is independent of the sourcing activities of distributors. The SCOR Level 3 models for make-to-order standard/configurable products and for custom products are shown in Figure 16 and Figure 17, respectively. Different pools are used to represent the subcontractor, the distributors, the manufacturers, the plants, and the suppliers. The subcontractor's headquarter, warehouse, and the construction site are separated by lanes.

3.3.3 BPMN for SCOR Level 4 Modeling

The complexity of the implementation for different Level 3 processes can vary. Figure 18 illustrates the BPMN representation of a SCOR Level 4 model for the fairly complex Level 3 process “Manu D2.2 Receive, Configure, Enter & Validate Order” performed by manufacturers, which is shown in Figure 16. The illustrated Level 4 process model involves purchase order processing, validation, feasibility check, and evaluation. These processes and their arrangements depicted in Figure 18 are only one of the many possible configurations. In fact, SCOR Level 4 models are specific to company and product. The SCOR documents do not provide the detailed process components, process structures, and implementation. Users need to define the Level 4 models to fit their own needs and situations.

4. Supply Chain Performance Monitoring

In addition to describing the network structure of a supply chain, SCOR models can also be leveraged in the development of information systems for supply chain integration and management. This section presents a development framework that leverages SCOR Level 3 and Level 4 models to build a supply chain performance monitoring system for construction projects.

In the construction industry, consumers increasingly place a higher value on quality than on loyalty to suppliers, and price is often not the only determining factor in making choices (Oakland and Marosszeky 2006). Performance management is a common means to improve quality level and to maintain a high quality. Performance monitoring and measurement is at the heart of the performance management processes (Bititci et al. 1997). The lack of performance measurement systems that spans the entire supply chain is one of the major obstacles to effective supply chain management (Chan 2003; Ross 1998; Wong and Wong 2007). In the construction

industry, various researchers have developed conceptual frameworks and systems for the monitoring and measurement on the performance at the project level (Cheung et al. 2004; Kagioglou et al. 2001; Yu et al. 2007). However, studies on the performance monitoring and measurement systems of supply chains in construction projects are lacking. Supply chain performance monitoring and measurement systems allow project participants to identify any bottleneck in a supply chain and offer the basis for supply chain process evaluation and improvement. Therefore, a performance monitoring system can help contractors to evaluate suppliers' information for use in future projects.

Building a supply chain performance monitoring system is a non-trivial task because it involves understanding and integration across organizational boundaries. Traditionally, supply chain performance is measured in the form of scorecards or reports through interviews or questionnaires. These approaches are labor-intensive in the data collection processes and often provide information with time lags. Nowadays the Internet provides a means to instantaneously share and integrate distributed information and applications at low cost. Monitoring supply chain performances and sharing the data across company boundaries can now be performed conveniently over the web. This section describes the use of the Internet and web services technologies for the development of a web-enabled performance monitoring system for construction supply chains.

The system development framework, as illustrated in Figure 19, adopts a model-based service oriented approach. At the beginning of the system design phase, the supply chain network and its members are identified and modeled through the SCOR Level 1 and Level 2 modeling framework. Process maps of internal and external supply chain operations are then produced through SCOR Level 3 and Level 4 modeling and represented in the BPMN standard.

Performance metrics for each SCOR Level 3 process are specified, with the aid of the SCOR guidelines. Whenever necessary, the SCOR Level 4 BPMN models are modified to measure and record the specified performance metrics. In the system implementation phase, the SCOR Level 3 and Level 4 models are then converted into web services execution language BPEL files. Implementation details such as port types of the connected web services are added to the BPEL files, which are finally incorporated to a prototype service oriented collaborative system SC Collaborator. We can reuse the modeling techniques in Section 3 for the supply chain network modeling and the process modeling in the system development framework. The following sections describe the incorporation of performance metrics in a process model and the conversion of the process model into an executable language.

4.1 Supply Chain Performance Metrics

What to measure and how to measure should be clearly defined when developing a performance monitoring and measurement system. Various performance metrics for supply chain management have been suggested, investigated, and analyzed in literature (Gunasekaran and Kobu 2007; Gunasekaran et al. 2004; Gunasekaran et al. 2001; Hausman 2004; Kleijnen and Smits 2003; Lambert and Pohlen 2001). Gunasekaran et al. (2001) emphasizes performance metrics related to suppliers, delivery performance, customer-service, and inventory and logistics costs in a supply chain. Kleijnen and Smits (2003) analyzes performance metrics in fill rate, confirmed fill rate, response delay, stock level, delivery delay, and sales/inventory ratio. Gunasekaran and Kobu (2007) reviews recently published literature on performance measurement in supply chains and summarizes 27 key performance indicators for supply chain management. In this research, we refer to the guidelines for supply chain performance metrics in the SCOR framework (Supply Chain Council (SCC) 2008).

The SCOR document suggests 524 distinct performance metrics that are divided into five categories: supply chain reliability (RL), responsiveness (RS), agility (AG), costs (CO), and asset management (AM). Reliability measures the accuracy and conditions of the products, documentation, packaging, etc. in the delivering process. Responsiveness refers to the speed at which a supply chain provides products to the customer. Agility measures the flexibility and adaptability of a supply chain to respond to the changes in markets. Costs correspond to the costs associated with operating the supply chain. Asset management measures the effectiveness in managing assets to support supply chain operations. The performance metrics are hierarchically structured in three levels. For example, as illustrated in Figure 20, the performance metric “Reserve Resources & Determine Delivery Date Cycle Time” belongs to “RS 2.3 Delivery Cycle Time” on Level 2, which belongs to “RS 1.1 Order Fulfillment Cycle Time” on Level 1 in the Supply Chain Responsiveness category.

Level 3 performance metrics are related to SCOR Level 3 processes. For example, the performance metric “Reserve Resources & Determine Delivery Date Cycle Time” measures the average time associated with reserving resources and determining a delivery date in the SCOR Level 3 processes “D1.3 Reserve Inventory and Determine Delivery Date” and “D2.3 Reserve Inventory and Determine Delivery Date.” Therefore, we can select the supply chain performance metrics in a process-based approach after the SCOR Level 3 modeling. Selection of performance metrics is specific to the characteristics of the project and the needs of the stakeholders. One approach is to first decide one or two performance categories of interest, and then selects the performance metrics in the categories of interest in each SCOR Level 3 supply chain process.

For the case example, since timeliness was emphasized in the MEP processes in the student center construction project, performance metrics in the Supply Chain Responsiveness category are selected for most of the processes. Metrics in the Supply Chain Reliability category are also selected because unreliable and incomplete order fulfillment can delay the material delivery. For demonstration purpose, the selected metrics include mainly process cycle time, timeliness of product arrival, product conditions upon arrival, and documentation accuracy. [Table 1](#) enlists some of the supply chain performance metrics used in the student center construction case example.

Task elements can be added at the beginning and/or at the end of a SCOR Level 4 model to measure and record the performance values. To measure the cycle time of the process “D2.3 Reserve Inventory and Determine Delivery Date,” for example, a task is added after the start event to record the starting time of every instance of the process and a task is added right before the end event to calculate the time spent on the instance. The time spent is the cycle time for an instance of the D2.3 process. The performance value of “Reserve Resources & Determine Delivery Date Cycle Time” for a particular organization or a particular product type can be obtained by taking the average of the cycle time of the D2.3 process instances.

4.2 Conversion of BPMN Models into BPEL Files

BPMN models cannot be executed directly due to its high level of abstraction. However, BPMN models can be easily converted into BPEL (Organization for the Advancement of Structured Information Standards (OASIS) 2007), which is an XML-based Web services execution language for describing the interactions between a business process and external Web services. The converted BPEL files capture the process flow and logic specified in the BPMN models.

However, to make the converted BPEL files executable, specifications of the process activities and the connections have to be added.

BPMN models are stored and transferred using XML Metadata Interchange (XMI) format. XMI is a standard developed by OMG for exchanging metadata information via Extensible Markup Language (XML). To convert BPMN models into BPEL files, XMI output of the BPMN models are exported, and then parsed to extract the process definitions and sequences. [Figure 21](#)~~Figure 21~~ shows an example for the SCOR Level 3 process “Manu D2.2 Receive, Configure, Enter & Validate Order.” In the XMI output, every event, gateway, activity, and artifact object is represented as an individual `<vertices>` element, while every connecting object is represented as a `<sequenceEdges>` element. As illustrated in [Figure 21](#)~~Figure 21~~, an XMI file indicates the linkages between the flow objects (events, gateways and activities) represented in a BPMN model. We have built a Java conversion program to parse XMI files and to create a BPEL skeleton file for every BPMN model. The program instantiates a Java class `Process` for every extracted `<vertices>` element. Every `Process` instance has a process name, a process type, and a list of succeeding `Process` instances. The types of `<vertices>` elements that are extracted from an XMI file are listed in Table 2. The *name* and *activityType* attributes of a `<vertices>` element are used to describe the class instance. The *outgoingEdges* and *incomingEdges* attributes of `<vertices>` elements are matched to each other to regenerate the sequences and relationships of the flow objects. As illustrated in [Figure 21](#)~~Figure 21~~, for example, the *outgoingEdges* attribute of `<vertices>` element “start” matches the *incomingEdges* attribute of the succeeding `<vertices>` element “Assign PO Info.” The unique ids of these two elements are specified in the `<sequenceEdges>` element linking the `<vertices>` elements. *The*

<sequenceEdges> elements can also be used to check orphan flow objects or incomplete connections.

After parsing all the <vertices> elements in an XMI file, a linked list of instances of class `Process` can be produced internally. The linked list is converted into a tree hierarchy and exported into an XML file with the corresponding BPEL element tags. A <bpws:sequence> element is then inserted to encapsulate any list of two or more <bpws:empty> elements on the same hierarchical level. An <bpws:process> tag is finally added as the beginning element of the XML-based BPEL skeleton file. [Figure 21](#) shows the BPEL skeleton file resulted from the XMI file for the process “Manu D2.2 Receive, Configure, Enter & Validate Order.”

As shown in Figure 22, implementation details are then added to the BPEL skeleton with the aid of Eclipse BPEL Visual Designer (Eclipse Foundation 2009), an open source BPEL editor developed by Eclipse Foundation. The graphical user interface of the eclipse plug-in allows users to define the activity operations and the partner link elements easily. The <bpws:empty> elements are replaced by <bpws:receive>, <bpws:reply>, <bpws:invoke>, or <bpws:assign> elements. For every <bpws:receive>, <bpws:reply> and <bpws:invoke>, the *partnerLink*, *portType*, *operation*, and *variable* attributes should be defined. The specifications of <bpws:assign> elements and the conditions of <bpws:if> elements can also be conveniently defined in Eclipse BPEL Visual Designer. In the completed BPEL file illustrated in Figure 22, conditions are defined in <bpws:if> elements and implementation details are added to different <bpws:receive>, <bpws:reply>, and <bpws:invoke> elements.

5. Implementation

The BPEL files of the SCOR Level 3 models and Level 4 models are deployed in SC Collaborator, a service oriented collaborative system that we have developed (Cheng et al. 2009).

As shown in [Figure 24](#), the SC Collaborator system leverages web portal technology to provide a secure and customizable user interface, and implements service oriented architecture to integrate information, applications and services in a flexible and reusable manner. [Figure 23](#) shows the system architecture of the SC Collaborator framework. The framework consists of an access control engine, a database support, and four layers of integrated functionalities – a communication layer, a portal interface layer, a business application layer, and an extensible computing layer. The communication layer provides a communication channel for users to access the system. The portal interface layer serves as a unified and customizable platform to support interactions between users and the system. The business applications layer provides an environment for executing various business processes such as decision making and connecting to external data sources, applications and services. The extensible computing layer is potentially comprised of numerous databases, software applications and web services that the business applications layer can integrate to support high-level or computationally intensive business functions. Open source technologies are leveraged in the system implementation. In specific, MySQL (Sun Microsystems 2007) and Hibernate framework (Red Hat 2008) are used for the database support, Apache ODE (Apache Software Foundation 2008a) for orchestration of web service units and execution of BPEL files, Liferay Portal (Liferay 2008) for the portal user interface, and Apache Tomcat (Apache Software Foundation 2007), Apache Struts (Apache Software Foundation 2008b) and Apache Axis (Apache Software Foundation 2006) for the communication layer.

As shown in [Figure 24](#)~~Figure 24~~, information sources, application functionalities, and system operations in the system are wrapped and deployed into individual web service units, which can be located and invoked via standardized Simple Object Access Protocol (SOAP) (World Wide Web Consortium (W3C) 2000). These reusable web service units are integrated and orchestrated into different workflows for various business processes using BPEL models. Each web service unit is associated with a Web Service Description Language (WSDL) (World Wide Web Consortium (W3C) 2004) file, which describes the schema, functions and location of the web service. The WSDL file of a web service provides BPEL models with the information on how to invoke a specific function of the connected web service. Each BPEL model describes the relationships of service units and the logic involved during the connections among the service units. The SCOR Level 3 and Level 4 models developed in Section 3.3 and converted in Section 4.2 are deployed in the BPEL-enabled SC Collaborator system. Upon deployment, WSDL files are generated for the Level 3 and Level 4 BPEL model. The WSDL of the deployed Level 4 BPEL model for the process “Manu D2.2 Receive, Configure, Enter & Validate Order” is depicted in Figure 25. The BPEL process files of SCOR Level 4 models integrate other web service units in the system to perform individual SCOR Level 3 processes. The BPEL process files of SCOR Level 3 models link different Level 4 models together to allow automation of SCOR Level 4 implementations. These Level 3 BPEL models are invoked by separate application portlet units on the business applications layer in the SC Collaborator system for managing and monitoring various supply chain operations. The portlet units need to be contained and managed by the portal layer to provide a centralized management and user interface.

6. Scenario Demonstration

This section demonstrates the construction supply chain performance measurement system that is developed for the student center construction project using the system development framework presented in the previous sections. The scenario is based on real data from the construction project, but the names of the companies are modified for privacy and proprietary reasons. The first step of the system application is company registration. The submittals from the subcontractors provide the general contractor with information about the suppliers of every product. At the beginning of the system application, the general contractor added the names of the distributors and manufacturers for each subcontractor using an online form in the system (Figure 26). Modification and removal of the names are also allowed through the online form. The subcontractors then initiated the SCOR process for any product when they started procurement according to their schedules.

The system offers a product-based tracking of the supply chain status at the SCOR Level 3. The start time and finish time for each invocation of SCOR Level 3 processes were recorded in the system. The general contractor and subcontractors can log in the system and check the current status of any products they have procured (Figure 27). Execution history of the SCOR Level 3 processes is recorded and stored in the back-end database for each product. In addition, contractors can also share the SCOR status records with the members along their supply chains as well as other project participants. For instance, the electrical subcontractor has shared its information of the electrical components to the general contractor for supply chain visibility. The information was also shared with the mechanical subcontractor and the plumbing subcontractor because there were many overlaps of the MEP activities in the project. The sharing settings can be adjusted by the contractors who own the information.

The key supply chain performance metrics used in this case scenario are listed in [Table 1](#). The developed performance measurement system shows the values of the performance metrics for each manufacturer, distributor, and contractor (Figure 28). This information helps the contractors compare their business partners, evaluate their supply chains, and identify bottlenecks and underperformed portions along their supply chains. The information may also indicate performance improvement or deterioration and offer guidelines for future supplier selection and project scheduling. In Figure 28, the values of average cycle times were obtained from the schedules provided by the contractors and suppliers. However, it should be pointed out that the companies did not keep track of the numbers of products received on-time, with correct documentation and in perfect condition, days per schedule change, quantity per shipment, and documentation accuracy in the construction project. The value ranges shown in Figure 28 were based on the estimations provided by the companies.

For instance, as illustrated in Figure 28, all of the products the electrical subcontractor purchased from the distributor *International Electric* were delivered on time as scheduled. However, not all of the received products came with correct shipping documents, which may lead to confusion of the electrical subcontractor and could be improved in the rest of the project or even in future collaborations. Furthermore, percentage of products in perfect condition did not reach 100%. Perfect condition of an item means that the item meets specification, has correct configuration, is undamaged, is accepted by the customer, is faultlessly installed, and is not returned for repair or replacement. Imperfect condition can be caused by poor transportation conditions, lack of communication between the customer and the supplier, and incorrect documentations, etc. In this case, the subcontractor and the distributor may need to find the causes and prevent further problems. In addition, the time that the electrical subcontractor

generally spent on planning the procurement process was long relative to the duration of the whole sourcing process. It could be difficult and subjective to draw conclusions on the length of the planning time, but the measure points out a potential aspect that the subcontractor can pay attention to and improve in the future.

7. Summary and Future Work

This paper demonstrates the modeling of construction supply chains using the Supply Chain Operations Reference (SCOR) modeling framework. The mechanical, electrical and plumbing (MEP) supply chains of a student center construction project have been studied retrospectively and used as a case example. In the MEP supply chains we studied, three major types of the construction supply chains were observed – stocked standard products, make-to-order standard/configurable products, and custom products. The three types of supply chains in the student center construction project are modeled through the Level 2, Level 3, and Level 4 modeling of the SCOR framework. SCOR Level 2 models describe the buyer-supplier interactions along supply chains. SCOR Level 3 models specify the material flows and information flows among the Level 3 process elements involved in the supply chains. The implementation details of Level 3 process elements are captured in the SCOR Level 4 models. The SCOR Level 3 and Level 4 models are represented in BPMN standard, which is a reader-friendly open standard for process modeling.

This paper also presents a model-based service oriented framework to develop a construction supply chain performance monitoring system. The system development framework consists of construction supply chain network, process modeling and definition, performance metrics selection, and process execution. The framework leverages open standards (BPMN,

BPEL, WSDL, and SOAP), open source software (SC Collaborator, MySQL, Liferay Portal, Apache Tomcat, Apache ODE, Axis framework, Struts framework, and Hibernate framework), and the SCOR modeling framework. The SCOR modeling framework provides a systematic approach to decompose a construction supply chain into process elements. The performance monitoring framework presented in this paper monitors a supply chain on the process element basis and implements each process element and its performance measurement as Web service components. Therefore, the SCOR modeling framework supports the presented performance monitoring framework. The SCOR Level 3 and Level 4 models developed in the first part of this paper are reused as the baseline in the system design phase. Performance metrics are then determined in a process-based approach for each Level 3 supply chain process element. For system implementation, the Level 3 and Level 4 BPMN models are converted into BPEL files, which are completed with the aid of an open source BPEL editing tool. The BPEL files are finally incorporated in the service oriented SC Collaborator system that we have developed in another research. The modified SC Collaborator system allows product-based supply chain tracking and organization-based performance monitoring, which are demonstrated in Section 6.

The system development framework presented in this paper leverages the SCOR modeling framework as the backbone. However, the framework is applicable to other supply chain models or process maps. In addition, the system developed in this research is not limited to only MEP supply chains in construction projects of medium scale. In a project of larger scale, the supply chain relationships may be more complex because subcontractors may subcontract some parts of their jobs to other companies. This results in layers of subcontractors each of which is associated with its supply chains with different trading partners. In this case, modifications of the structures and layouts in the SC Collaborator system are needed to meet the

actual project needs. However, the system in general can be applied to various types of construction supply chains and to projects of various sizes.

The three configurations of MEP supply chains described in this paper are based on our study on a student center construction project. The MEP supply chains in other construction projects may have different configurations in terms of organizations and business operations. The configuration of a supply chain may be affected by factors such as the common practice of the supply chain members, the scale and budget of the project, and the type of the construction. Therefore, we plan to study the MEP processes in various construction projects and attempt to validate the generality of the three supply chain configurations described in this paper. Furthermore, we plan to extend our research to other kinds of processes in a construction project, for example, steel erection and window installation. We will study the supply chains involved in these processes, model them using the SCOR framework, and build a performance monitoring system for these supply chains using the framework we presented in this paper. By extending the scope of our research, we hope to test the framework we have developed and to enhance its usability.

8. Acknowledgements

The authors would like to acknowledge the supports by the US National Science Foundation (NSF), Grant No. CMS-0601167, the Center for Integrated Facility Engineering (CIFE) at Stanford University, and the Enterprise Systems Group at the National Institute of Standards and Technology (NIST). The first author at Stanford University would like to thank DPR Construction and the anonymous subcontractors for their time and data for the case example presented in this paper. Any opinions and findings are those of the authors, and do not

necessarily reflect the views of NSF, CIFE, or NIST. No approval or endorsement of any commercial product by NIST, NSF, or Stanford University is intended or implied.

Bibliography

- Apache Software Foundation. (2006). "Apache Axis."
- Apache Software Foundation. (2007). "Apache Tomcat 5.5."
- Apache Software Foundation. (2008a). "Apache Orchestration Director Engine (ODE)."
- Apache Software Foundation. (2008b). "Apache Struts."
- Bititci, U. S., Carrie, A. S., and McDevitt, L. (1997). "Integrated performance measurement systems: a development guide." *International Journal of Operations and Production Management*, 17, 522-535.
- Chan, F. T. S. (2003). "Performance Measurement in a Supply Chain." *The International Journal of Advanced Manufacturing Technology*, 21(7), 534-548.
- Cheng, J. C. P., Law, K. H., Bjornsson, H., Jones, A., and Sriram, R. D. (2009). "A service oriented framework for construction supply chain integration." *Automation in Construction*, (submitted).
- Cheung, S. O., Suen, H. C. H., and Cheung, K. K. W. (2004). "PPMS: a web-based construction project performance monitoring system." *Automation in Construction*, 13(3), 361-376.
- Dainty, A. R. J., Briscoe, G. H., and Millett, S. J. (2001). "New perspectives on construction supply chain integration." *Supply Chain Management: An International Journal*, 6(4), 163-173.
- Eclipse Foundation. (2008). "BPMN Modeler, Version 0.8.0."
- Eclipse Foundation. (2009). "BPEL Visual Designer, Version 0.4.0."
- Gunasekaran, A., and Kobu, B. (2007). "Performance measures and metrics in logistics and supply chain management: a review of recent literature (1995–2004) for research and applications." *International Journal of Production Research*, 45(12), 2819-2840.
- Gunasekaran, A., Patel, C., and McGaughey, R. E. (2004). "A framework for supply chain performance measurement." *International Journal of Production Economics*, 87(3), 333-347.
- Gunasekaran, A., Patel, C., and Tirtiroglu, E. (2001). "Performance measures and metrics in a supply chain environment." *International Journal of Operations and Production Management*, 21(1), 71-87.
- Hausman, W. (2004). "Supply Chain Performance Metrics." *The Practice of Supply Chain Management: Where Theory and Application Converge*, T. P. Harrison, H. L. Lee, and J. J. Neale, eds., 61-73.

- Huan, S. H., Sheoran, S. K., and Wang, G. (2004). "A review and analysis of supply chain operations reference (SCOR) model." *Supply Chain Management: An International Journal*, 9(1), 23-29.
- Kagioglou, M., Cooper, R., and Aouad, G. (2001). "Performance management in construction: a conceptual framework." *Construction Management and Economics*, 19(1), 85-95.
- Kleijnen, J. P. C., and Smits, M. T. (2003). "Performance metrics in supply chain management." *Journal of the Operational Research Society*, 54(5), 507-514.
- Lambert, D. M. (2008). *Supply chain management: processes, partnerships, performance*, Supply Chain Management Institute.
- Lambert, D. M., and Cooper, M. C. (2000). "Issues in supply chain management." *Industrial Marketing Management*, 29(1), 65-83.
- Lambert, D. M., and Pohlen, T. L. (2001). "Supply chain metrics." *International Journal of Logistics Management*, 12(1), 1-20.
- Liferay. (2008). "Liferay Open Source Enterprise Portal System."
- O'Brien, W. J., London, K., and Vrijhoef, R. "Construction supply chain modeling: a research review and interdisciplinary research agenda." *the 10th Annual Conference of the International Group for Lean Construction (IGLC-10)*, Gramado, Brazil, 129-148.
- Oakland, J., and Marosszeky, M. (2006). *Total Quality in the Construction Supply Chain*, Elsevier, Oxford, Great Britain.
- Object Management Group (OMG). (2005). *Unified Modeling Language (UML), Version 2.0*.
- Object Management Group (OMG). (2008). *Business Process Modeling Notation (BPMN), Version 1.1*.
- Organization for the Advancement of Structured Information Standards (OASIS). (2007). *Web Services Business Process Execution Language (WS-BPEL), Version 2.0*.
- Red Hat. (2008). "Hibernate framework."
- Ross, D. F. (1998). *Competing through supply chain management: creating market-winning strategies through supply chain partnerships*, Kluwer Academic Publishers.
- Sun Microsystems. (2007). "MySQL 5.0."
- Supply Chain Council (SCC). (2008). *Supply Chain Operations Reference (SCOR) Model, Version 9.0*.
- US Air Force. (1981). "Integrated computer-aided manufacturing (ICAM) architecture Part II, Vol. IV - function modelling manual (IDEF0)." *AFWAL-TR-81-4023*, Air Force Materials Laboratory, Wright-Patterson AFB, Ohio 45433.
- Wong, W. P., and Wong, K. Y. (2007). "Supply chain performance measurement system using DEA modeling." *Industrial Management and Data Systems*, 107(3), 361.
- World Wide Web Consortium (W3C). (2000). *Simple Object Access Protocol (SOAP), Version 1.1*, May.

World Wide Web Consortium (W3C). (2004). *Web Services Description Language (WSDL), Version 2.0*.

Yu, I., Kim, K., Jung, Y., and Chin, S. (2007). "Comparable performance measurement system for construction companies." *Journal of Management in Engineering*, 23(3), 131-139.



Figure 1: SCOR Level 1 modeling (Supply Chain Council (SCC) 2008)

		Level		
		#	Description	Schematic
SCOR Model	↑	1	Top Level (Process Types)	
		2	Configuration Level (Process Categories)	P1: Plan Supply Chain; P2: Plan Source; P3: Plan Make; P4: Plan Deliver; P5: Plan Return
		3	Process Element Level (Decompose Processes)	
Not Included in SCOR Doc	↑	4	Implementation Level (Decompose Process Elements)	

Figure 2: Four levels of SCOR business processes (Supply Chain Council (SCC) 2008)

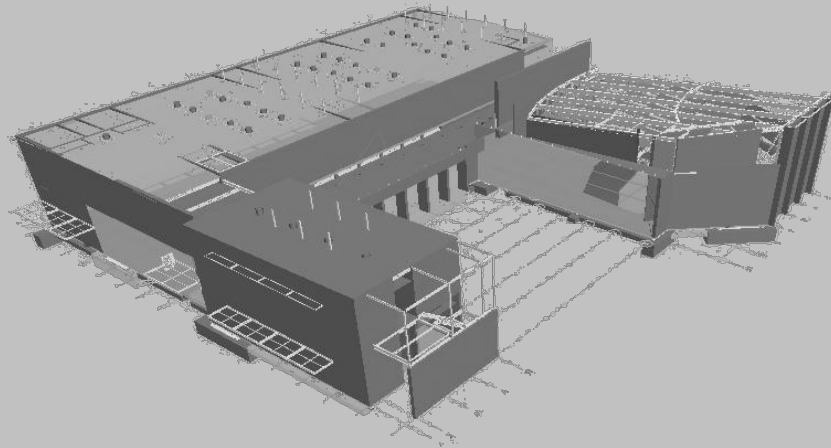

Figure 3: 3D model of the two-storey high school student center

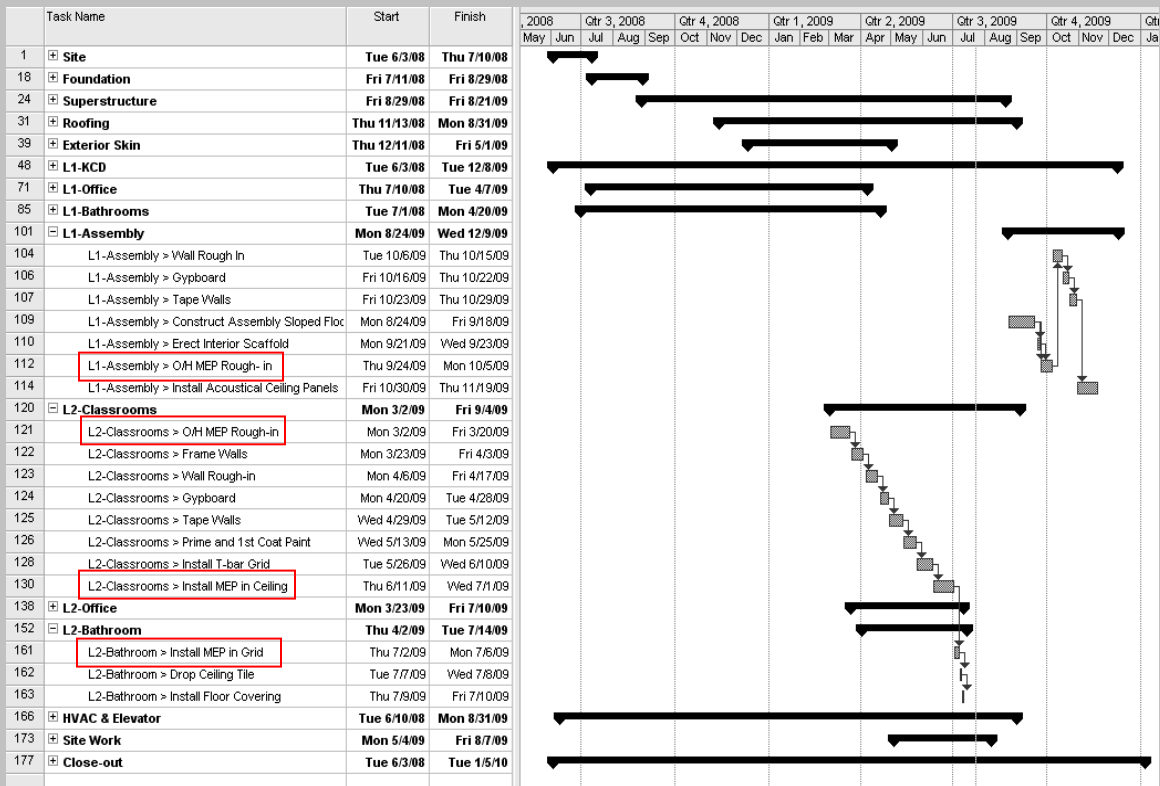

Figure 4: Project schedule showing only the tasks on the critical path

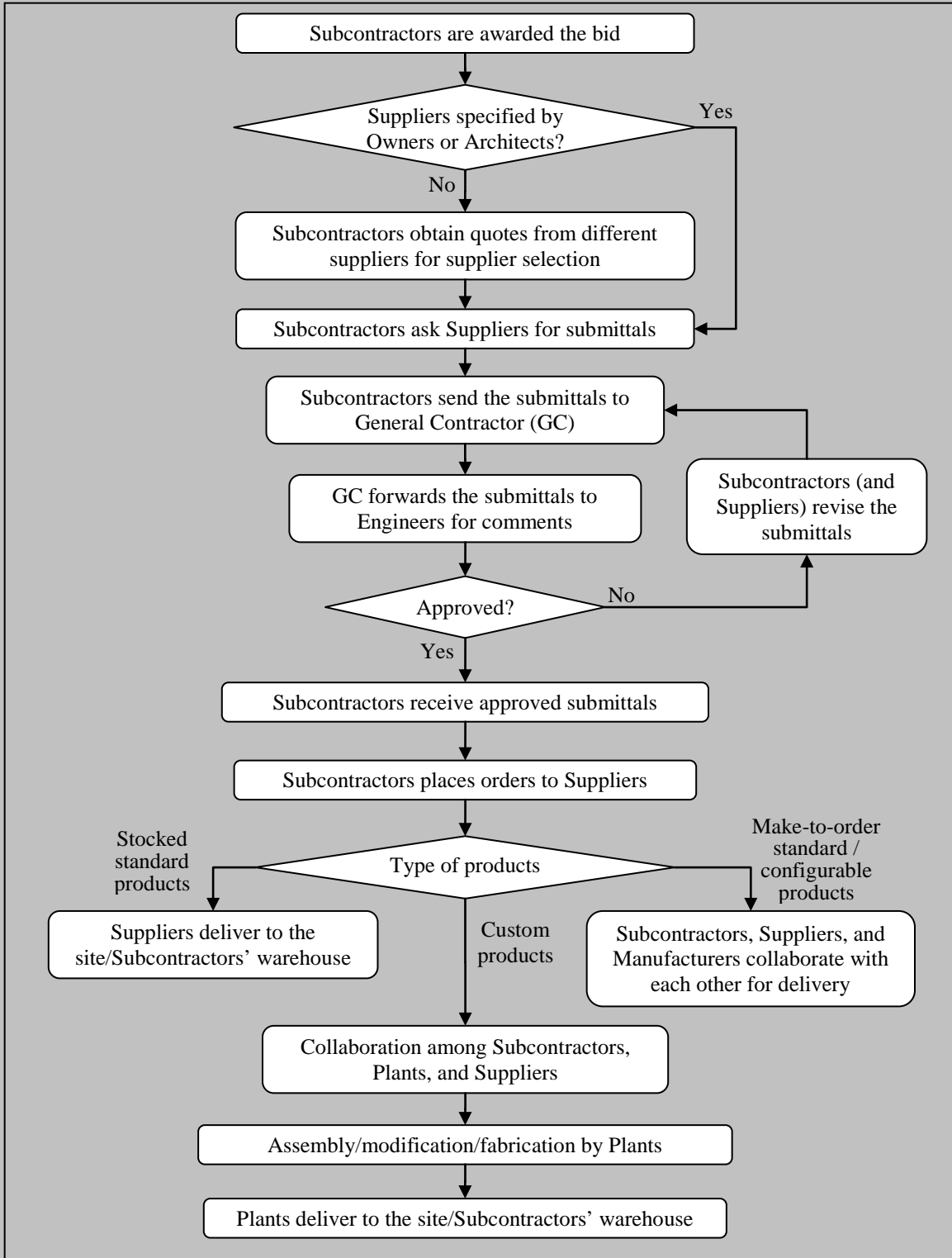

Figure 5: Flow chart of a typical material planning, procurement, and delivery management process in construction projects

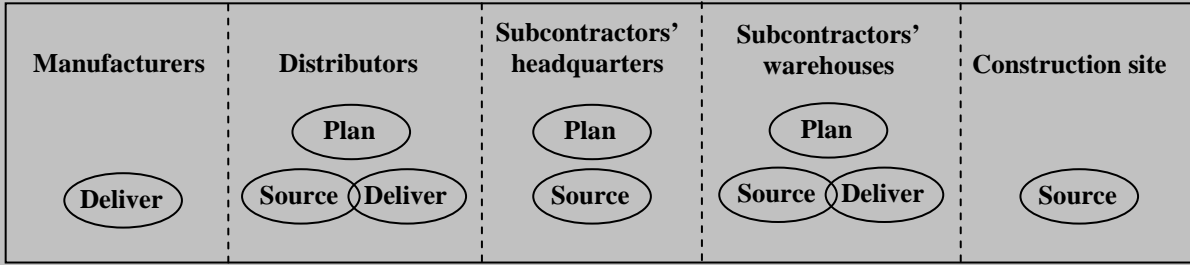

Figure 6: SCOR Level 1 model for a typical construction supply chain for stocked standard products

(P1: Plan Supply Chain; P2: Plan Source; P4: Plan Deliver; S1: Source Stocked Product; D1: Deliver Stocked Product)

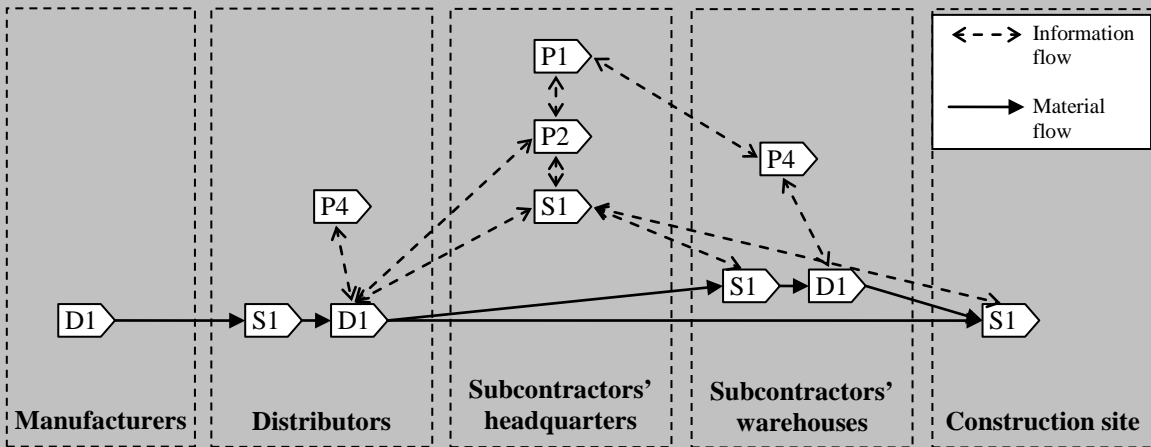

Figure 7: SCOR Level 2 model for a typical construction supply chain for stocked standard products

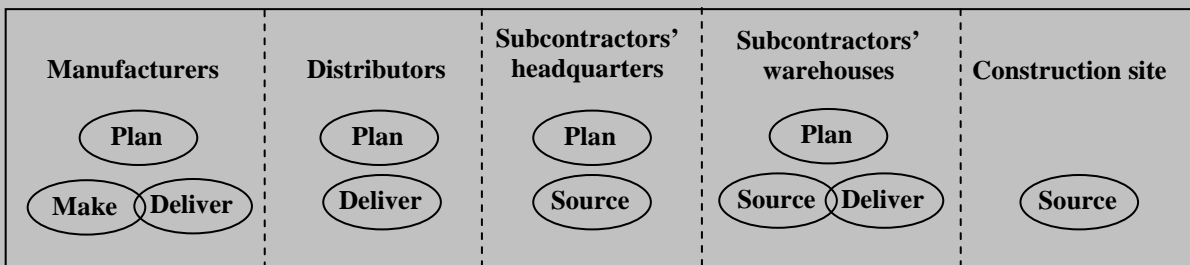

Figure 8: SCOR Level 1 model for a typical construction supply chain for make-to-order standard/configurable products

(P1: Plan Supply Chain; P2: Plan Source; P3: Plan Make; P4: Plan Deliver; S1: Source Stocked Product; S2: Source Make-to-Order Product; M2: Make-to-Order; D1: Deliver Stocked Product; D2: Deliver Make-to-order Product)

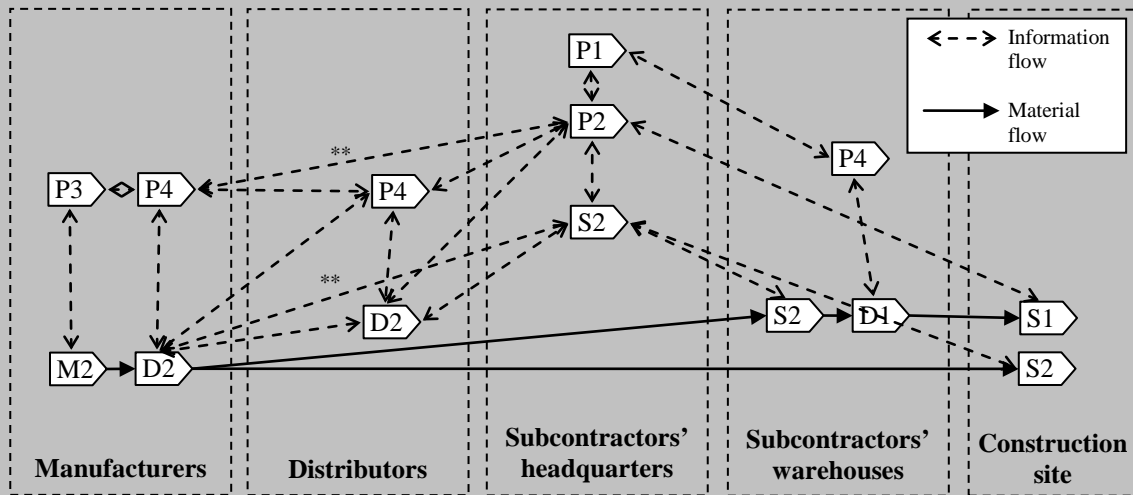

Figure 9: SCOR Level 2 model for a typical construction supply chain for make-to-order standard/configurable products

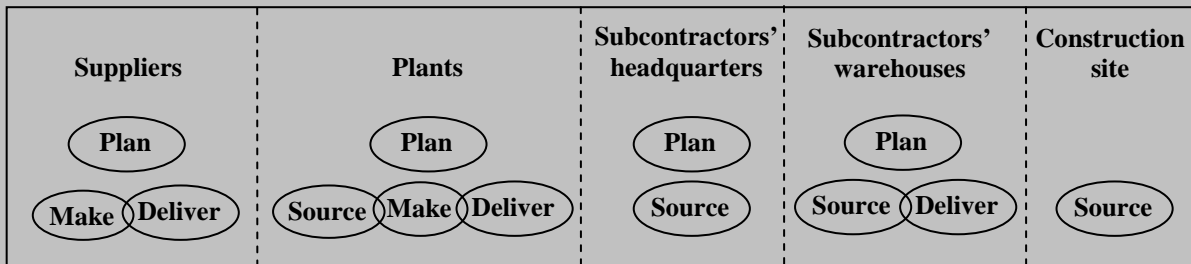

Figure 10: SCOR Level 1 model for a general construction supply chain for custom products

(P1: Plan Supply Chain; P2: Plan Source; P3: Plan Make; P4: Plan Deliver; S1: Source Stocked Product; S2: Source Make-to-Order Product; S3: Source Engineer-to-Order Product; M1: Make-to-Stock; M2: Make-to-Order; M3: Engineer-to-Order; D1: Deliver Stocked Product; D2: Deliver Make-to-order Product; D3: Deliver Engineer-to-Order Product)

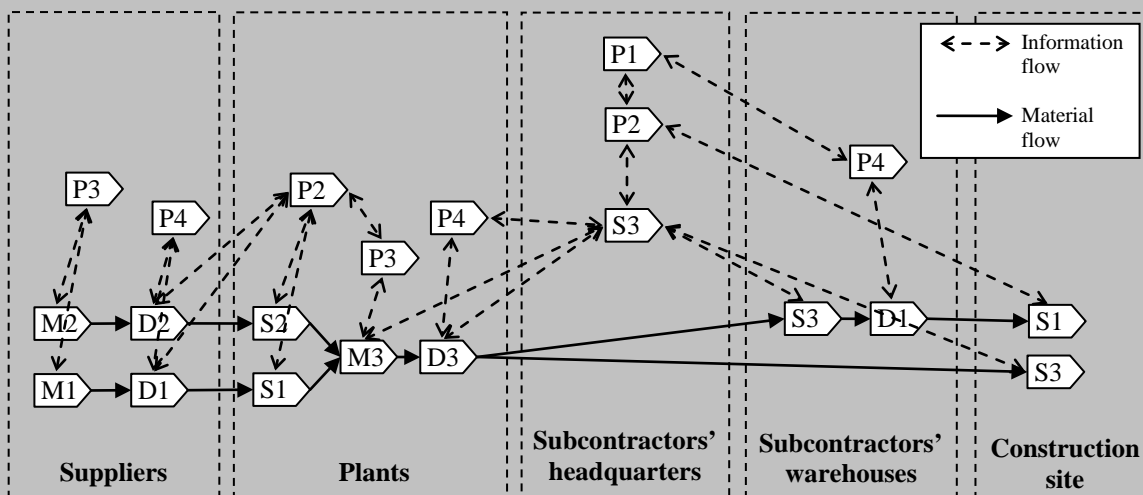

Figure 11: SCOR Level 2 model for a general construction supply chain for custom products

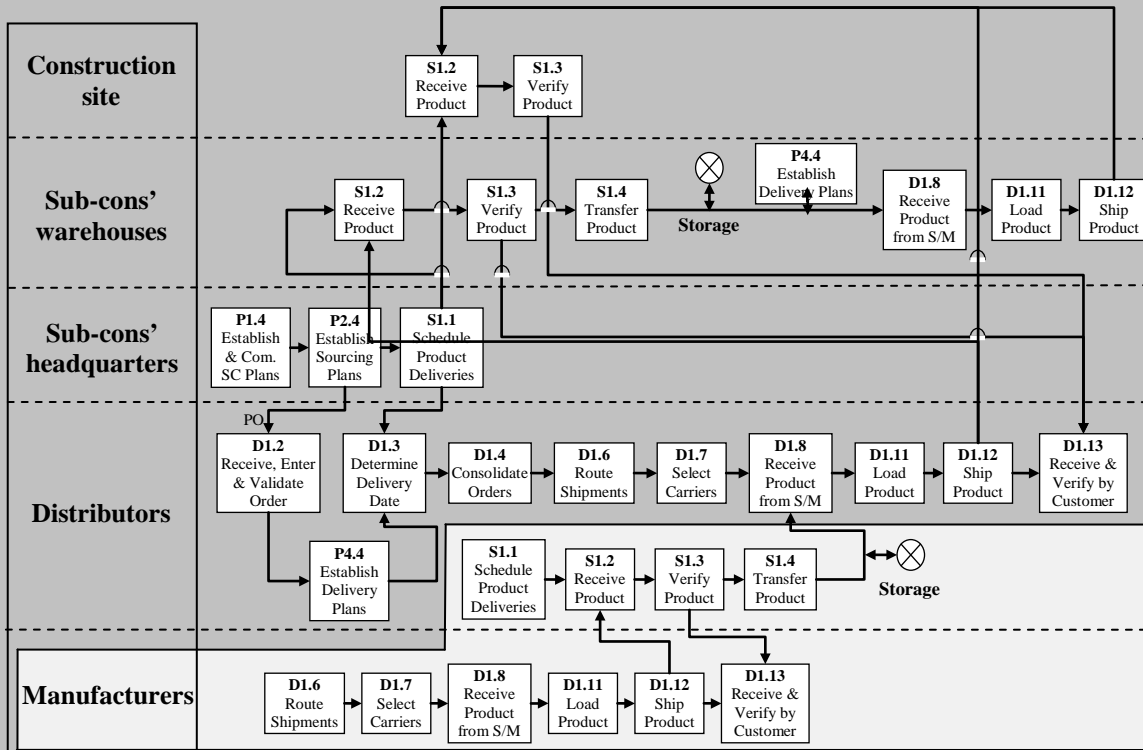

Figure 12: SCOR Level 3 model for a typical construction supply chain for stocked standard products

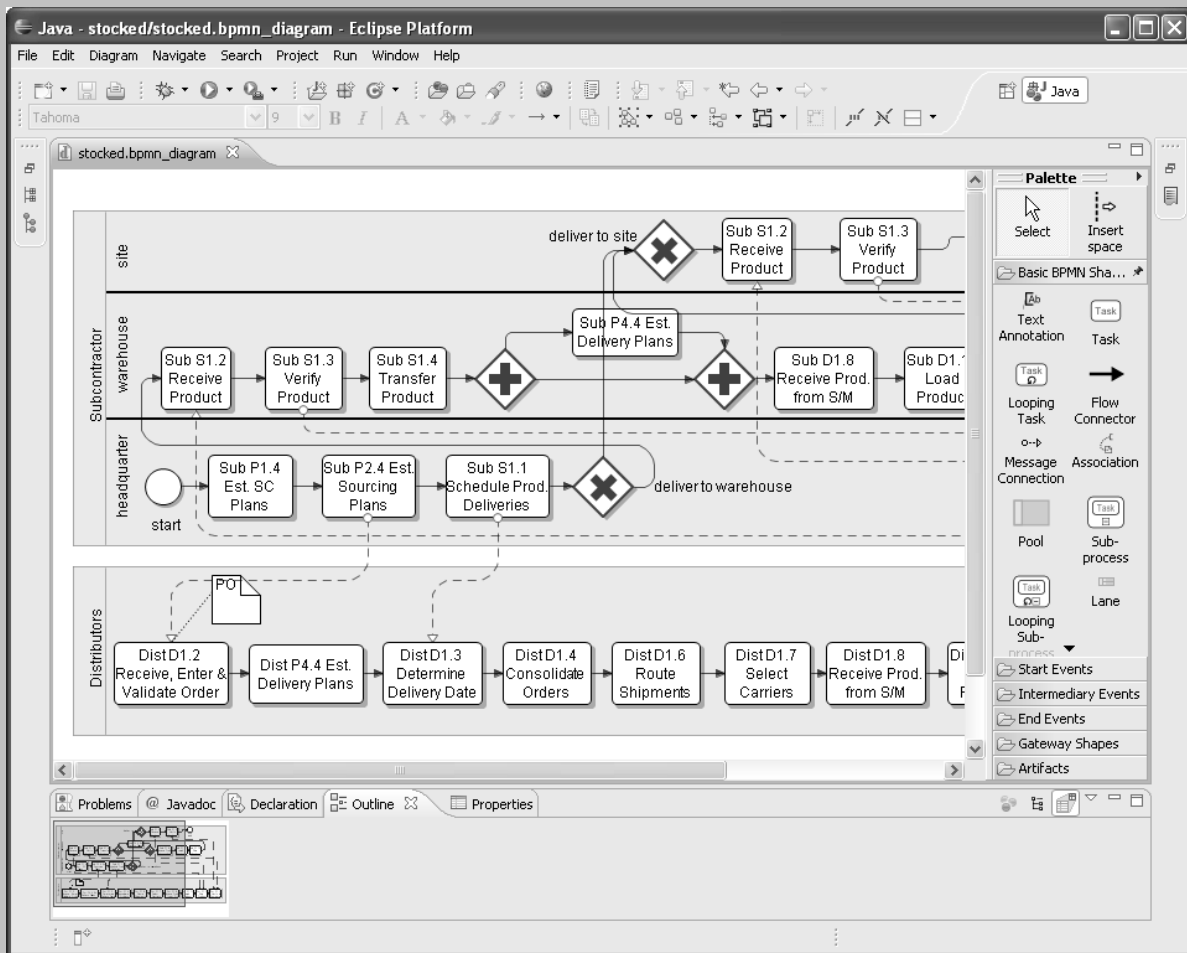

Figure 13: Snapshot of Eclipse BPMN Modeler

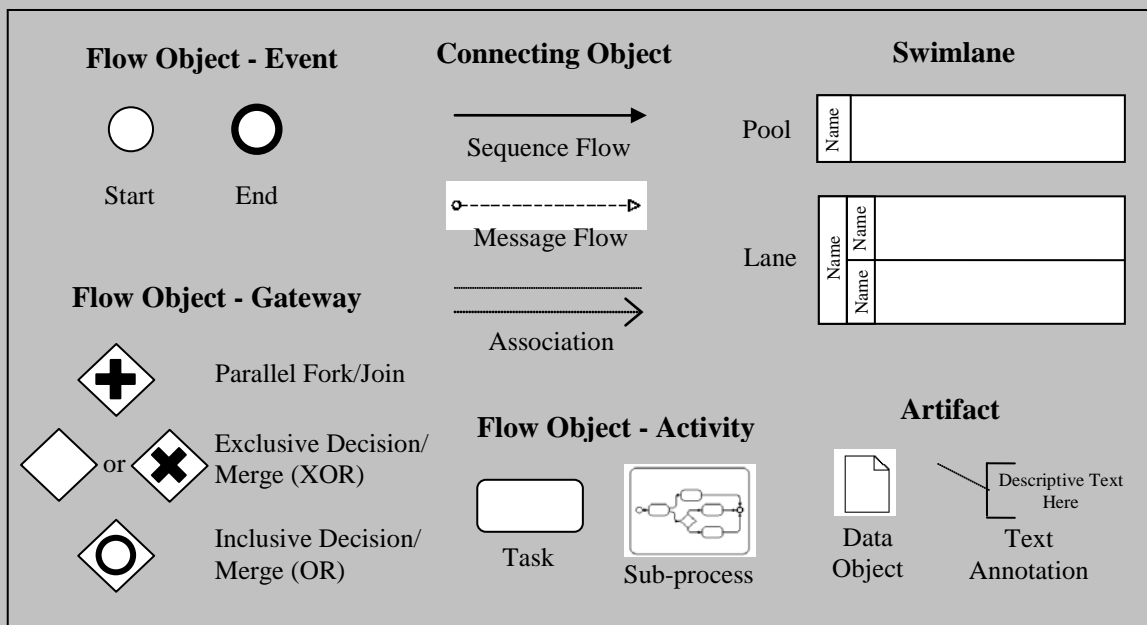

Figure 14: Core components in BPMN standard

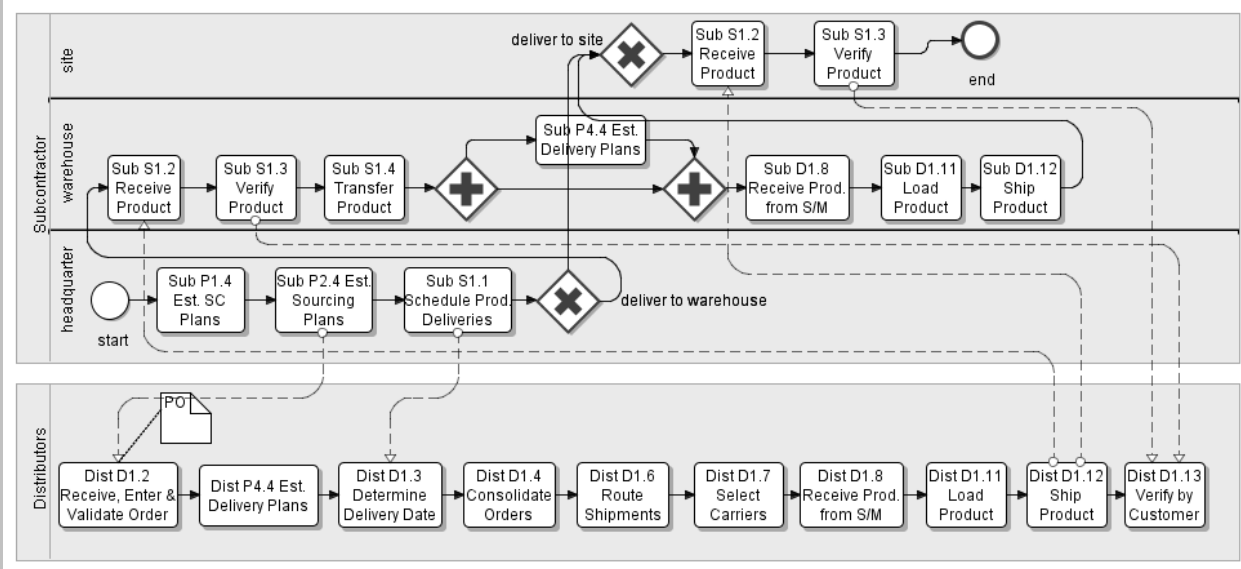

Figure 15: BPMN representation of the SCOR Level 3 model for stocked standard products

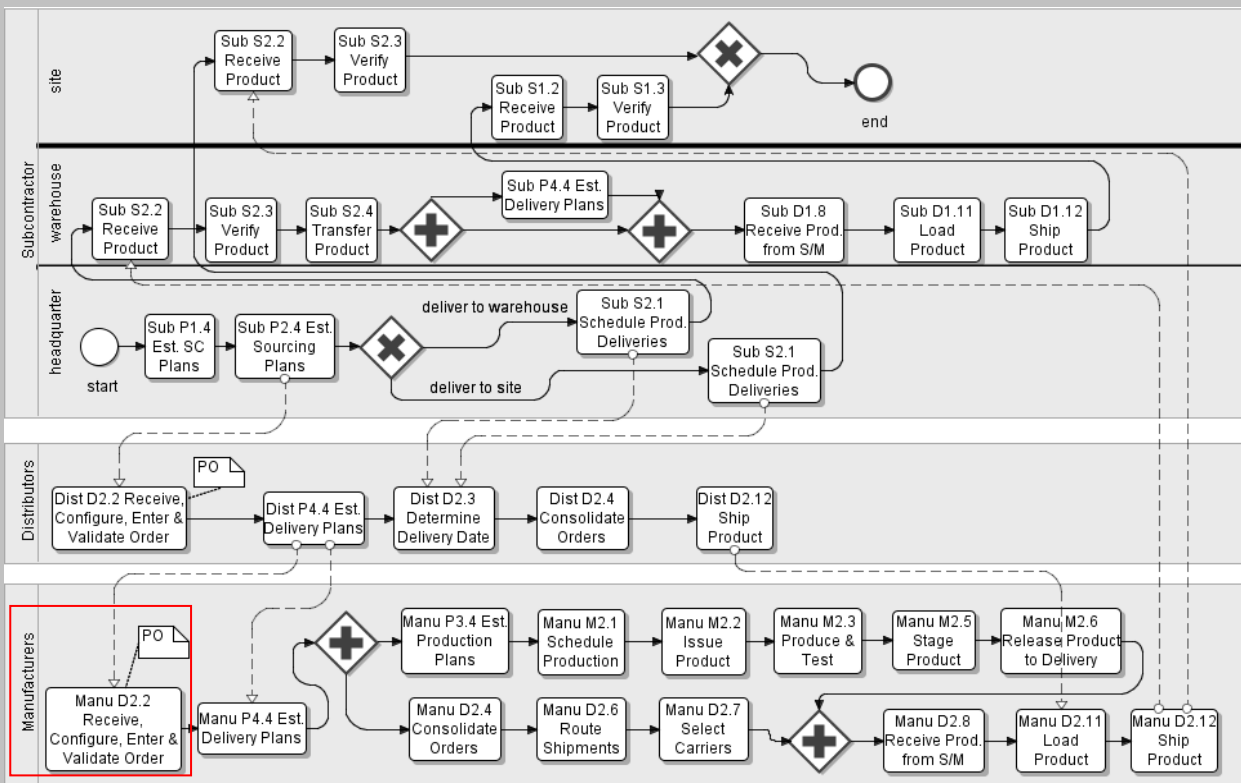

Figure 16: BPMN representation of the SCOR Level 3 model for make-to-order standard/configurable products

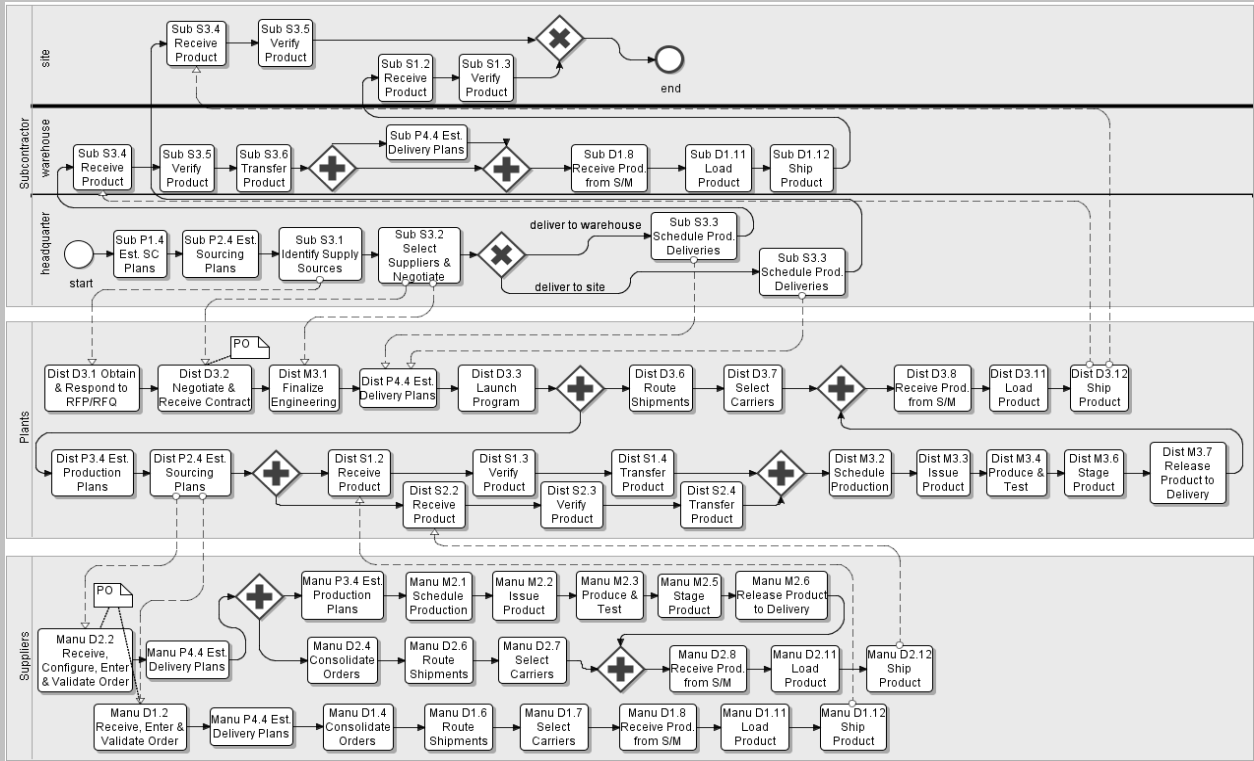

Figure 17: BPMN representation of the SCOR Level 3 model for custom products

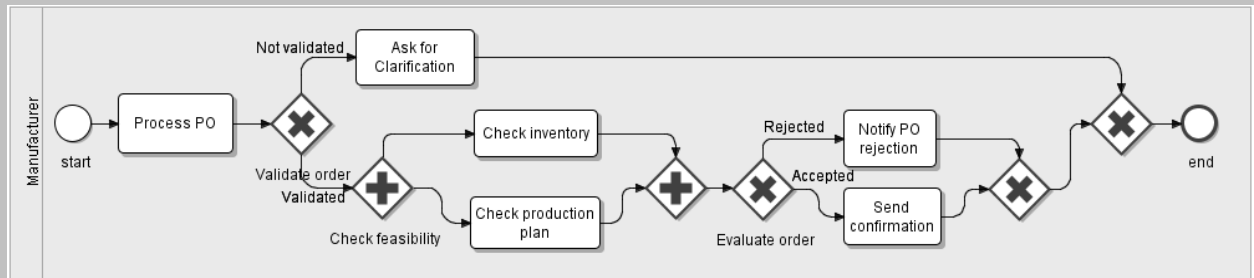

Figure 18: BPMN graphical representation of the process “Manu D2.2 Receive, Configure, Enter & Validate Order” in Figure 16

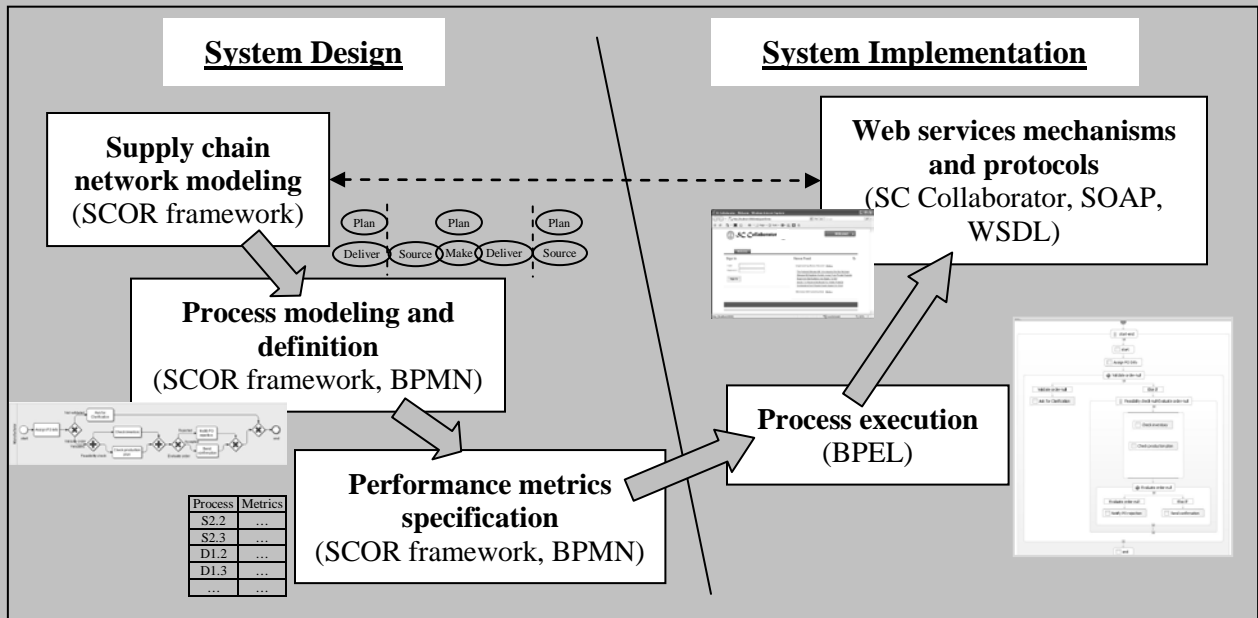

Figure 19: Development framework for service oriented supply chain performance monitoring systems using the SCOR framework, open standards, and open source technologies

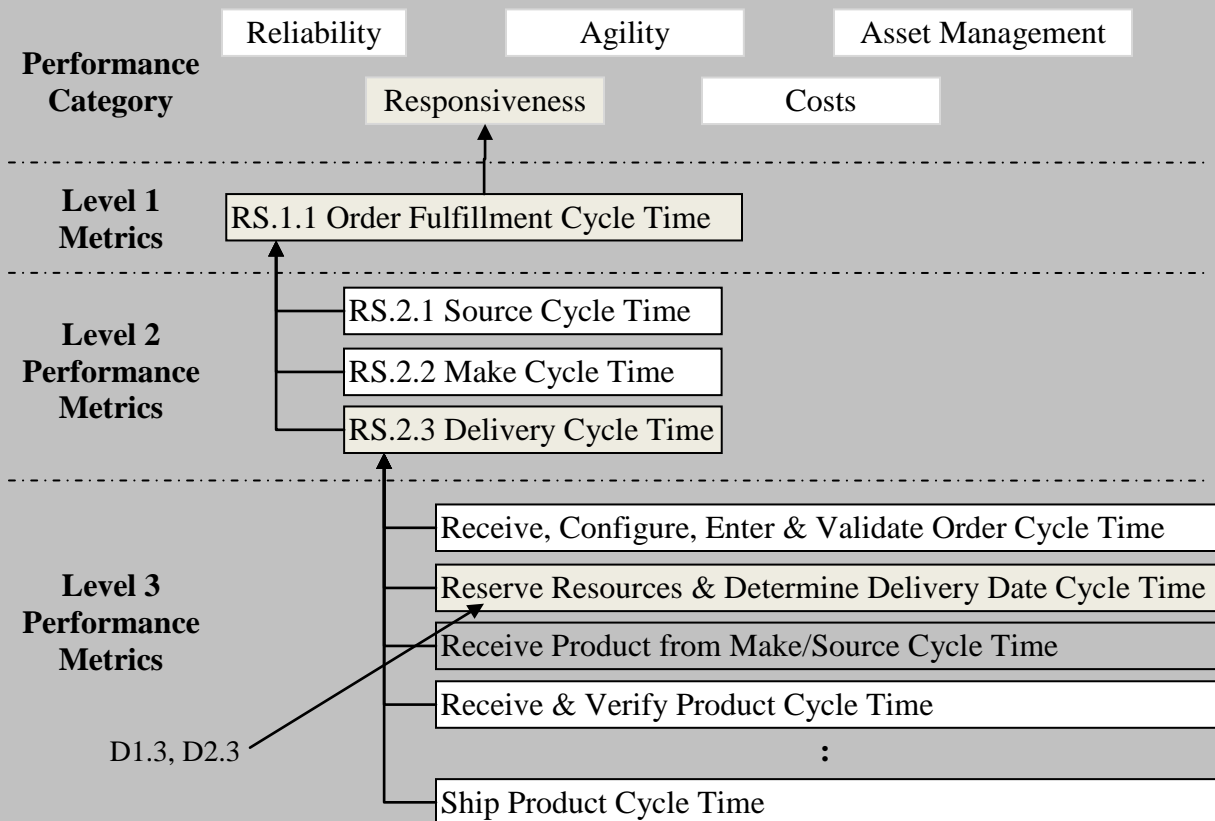

Figure 20: Performance metrics hierarchically structured in the SCOR guidelines

SCOR Level 4 model for D2.2 process (in XMI)

```
<?xml version="1.0" encoding="UTF-8"?>
<bpmn:BpmnDiagram xmi:version="2.0"
xmlns:xmi="http://www.omg.org/XMI"
xmlns:bpmn="http://stp.eclipse.org/bpmn"
xmi:id="_7eIVwYIMEd6DcYMaJrJywg" id="_7eIVwYIMEd6DcYMaJrJywg">
<pools xmi:type="bpmn:Pool" xmi:id="_7fUokIYMEd6DcYMaJrJywg"
id="_7fUokIYMEd6DcYMaJrJywg" name="Manufacturer">
<vertices xmi:type="bpmn:Activity"
xmi:id="_ED9jIYNEd6DcYMaJrJywg" id="_ED9jIYNEd6DcYMaJrJywg"
outgoingEdges="ZJwbsYYOE6DcYMaJrJywg" name="start"
activityType="EventStartEmpty"/>
<vertices xmi:type="bpmn:Activity"
xmi:id="_7fUok4YMEd6DcYMaJrJywg" id="_7fUok4YMEd6DcYMaJrJywg"
outgoingEdges="oin4kYNEd6DcYMaJrJywg"
incomingEdges="ZJwbsYYOE6DcYMaJrJywg" name="Assign PO Info"
activityType="Task"/>
:
<vertices xmi:type="bpmn:Activity"
xmi:id="_Xy4vYIYOEd6DcYMaJrJywg" id="_Xy4vYIYOEd6DcYMaJrJywg"
incomingEdges="Xy4vaoyOE6DcYMaJrJywg" name="end"
activityType="EventEndEmpty"/>
<sequenceEdges xmi:type="bpmn:SequenceEdge"
xmi:id="ZJwbsYYOE6DcYMaJrJywg" id="ZJwbsYYOE6DcYMaJrJywg"
source="_ED9jIYNEd6DcYMaJrJywg"
target="_7fUok4YMEd6DcYMaJrJywg"/>
<sequenceEdges xmi:type="bpmn:SequenceEdge"
xmi:id="_oin4kYNEd6DcYMaJrJywg" id="_oin4kYNEd6DcYMaJrJywg"
source="_7fUok4YMEd6DcYMaJrJywg"
target="_oiUwkYNEd6DcYMaJrJywg"/>
:
<sequenceEdges xmi:type="bpmn:SequenceEdge"
xmi:id="_r2D_QYNEd6DcYMaJrJywg" id="_r2D_QYNEd6DcYMaJrJywg"
name="Not validated" source="_oiUwkYNEd6DcYMaJrJywg"
target="_r16OQYNEd6DcYMaJrJywg"/>
</pools>
</bpmn:BpmnDiagram>
```

BPEL skeleton file

```
<?xml version="1.0" encoding="UTF-8"?>
<bpws:process exitOnStandardFault="yes"
name="Manufacturer" suppressJoinFailure="yes"
targetNamespace="http://eig.stanford.edu/bpel"
xmlns:bpws="http://docs.oasis-
open.org/wsbpel/2.0/process/executable">
<bpws:sequence name="start-end">
<bpws:empty name="start"/>
<bpws:empty name="Assign PO Info"/>
<bpws:if name="Validated">
<bpws:sequence name="Feasibility check-
Evaluate order">
<bpws:flow name="Feasibility check">
<bpws:empty name="Check inventory"/>
<bpws:empty name="Check production plan"/>
</bpws:flow>
<bpws:if name="Evaluate order">
<bpws:empty name="Notify PO rejection"/>
<bpws:elseif>
<bpws:empty name="Send confirmation"/>
</bpws:elseif>
</bpws:if>
</bpws:sequence>
<bpws:elseif>
<bpws:empty name="Ask for Clarification"/>
</bpws:elseif>
</bpws:if>
<bpws:empty name="end"/>
</bpws:sequence>
</bpws:process>
```

Figure 21: Conversion of the SCOR Level 4 model for the process “Manu D2.2 Receive, Configure, Enter & Validate Order” into BPEL file

BPEL skeleton file

```
<?xml version="1.0" encoding="UTF-8"?>
<bpws:process exitOnStandardFault="yes"
name="Manufacturer" suppressJoinFailure="yes"
targetNamespace=http://eig.stanford.edu/bpel
xmlns:bpws="http://docs.oasis-open.org/wsbpel/2.0/process/executable">
<bpws:sequence name="start-end">
<bpws:empty name="start"/>
<bpws:empty name="Assign PO Info"/>
<bpws:if name="Validated">
<bpws:sequence name="Feasibility check-
Evaluate order ">
<bpws:flow name="Feasibility check">
<bpws:empty name="Check inventory"/>
<bpws:empty name="Check production plan"/>
</bpws:flow>
<bpws:if name="Evaluate order">
<bpws:empty name="Notify PO rejection"/>
<bpws:elseif>
<bpws:empty name="Send confirmation"/>
</bpws:elseif>
</bpws:if>
</bpws:sequence>
<bpws:elseif>
<bpws:empty name="Ask for Clarification"/>
</bpws:elseif>
</bpws:if>
<bpws:empty name="end"/>
</bpws:sequence>
</bpws:process>
```

1

Eclipse BPEL Visual Designer

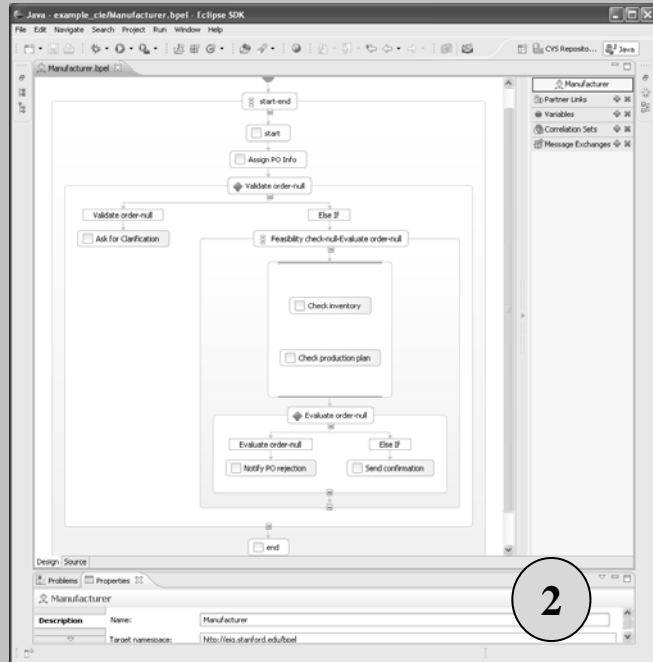

2

Complete BPEL file

```

:
<bpws:receive name="start" partnerLink="client" portType="tns:Manufacturer" operation="initiate"
variable="input" createInstance="yes"/>
:
<bpws:if name="Validated">
<bpws:condition expressionLanguage="http://www.w3.org/TR/1999/REC-xpath-
19991116"><![CDATA[$input.payload/tns:orderNumber!=" && $$input.payload/tns:productCode!=" &&
$$input.payload/tns:quantity>0 && $$input.payload/tns:fromCompany!=" ]]></bpws:condition>
<bpws:sequence>
<bpws:sequence name="Feasibility check-Evaluate order">
<bpws:flow name="Feasibility check">
<bpws:invoke name="Check inventory" partnerLink="production" operation="InventoryStatus"
inputVariable="productionRequest" outputVariable="productionResponse"/>
:
<bpws:reply name="Ask for Clarification" partnerLink="customer" operation="GetResult"
variable="customerResponse"></bpws:reply>
</bpws:elseif>
</bpws:if>
<bpws:invoke name="end" partnerLink="client" portType="tns:ManufacturerCallback"
operation="onResult" inputVariable="output" />
</bpws:sequence>
</bpws:process>
```

3

Figure 22: Completing the BPEL file by adding implementation details in Eclipse BPEL Visual Designer

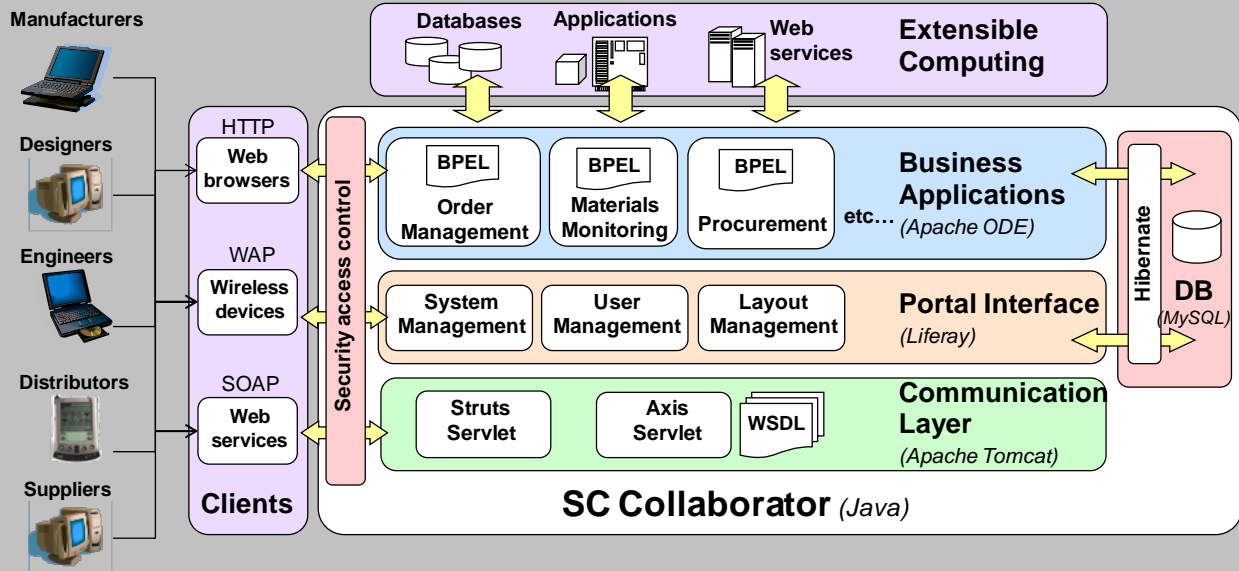

Figure 23: System architecture of the SC Collaborator system

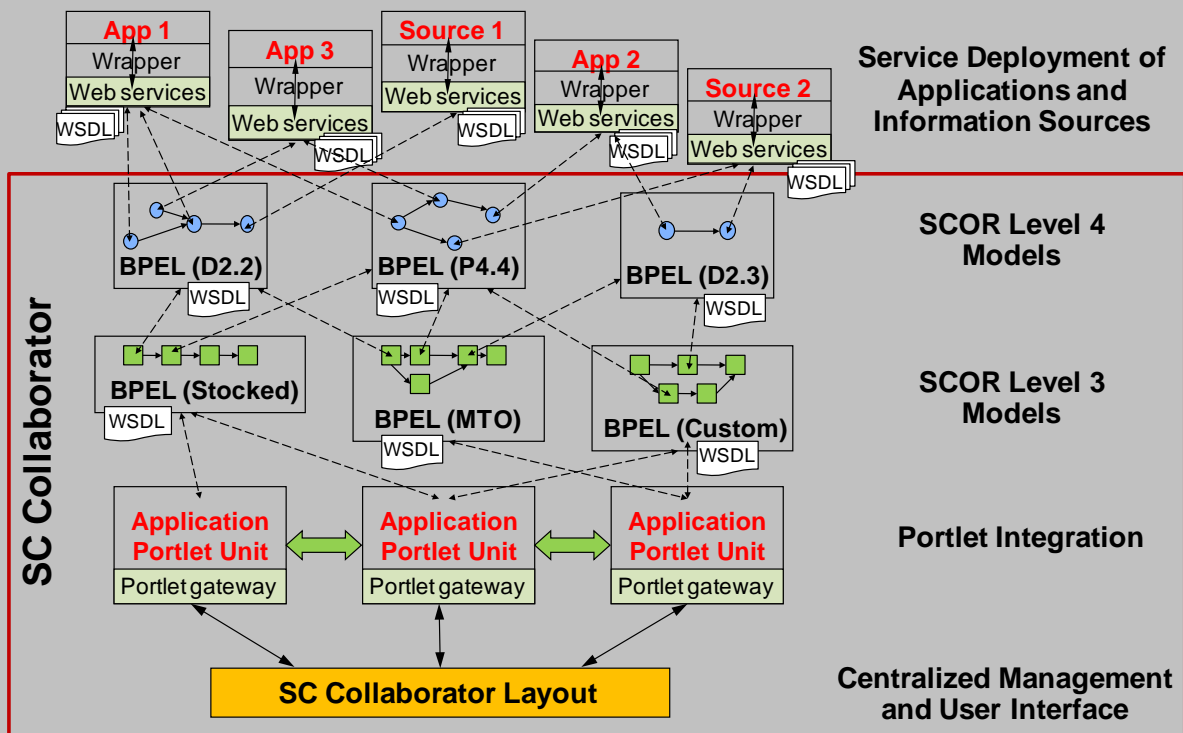

Figure 24: Incorporating SCOR Level 3 and Level 4 models in SC Collaborator

```

<?xml version="1.0" encoding="UTF-8" standalone="no"?>
<definitions xmlns="http://schemas.xmlsoap.org/wsdl/" xmlns:plnk="http://docs.oasis-
open.org/soap/2003/05/plnktype" xmlns:tns="http://eig.stanford.edu/bpel" name="Manufacturer"
targetNamespace="http://eig.stanford.edu/bpel"
xmlns:soap="http://schemas.xmlsoap.org/wsdl/soap/"
<plnk:partnerLinkType name="CustomerPLT">
  <plnk:role name="CustomerServiceProvider" portType="wsdl:customer"/>
</plnk:partnerLinkType>
<plnk:partnerLinkType name="ProdPLT">
  <plnk:role name="ProductionProvider" portType="wsdl:production"/>
  <plnk:role name="ProductionRequester" portType="wsdl:production"/>
</plnk:partnerLinkType>

<types><schema xmlns="http://www.w3.org/2001/XMLSchema" attributeFormDefault="unqualified"
elementFormDefault="qualified" targetNamespace="http://eig.stanford.edu/bpel">
  <element name="ManufacturerRequest">
    <complexType><sequence>
      <element name="fromCompany" type="string" />
      <element name="orderNumber" type="string" />
      <element name="product" type="string"/></element>
      <element name="productCode" type="string" />
      <element name="quantity" type="int" />
      <element name="color" type="string"/></element>
      <element name="price" type="string"/></element>
      <element name="delivery" type="string" />
      <element name="notes" type="string"/></element>
    </sequence></complexType>
  </element>
  <element name="ManufacturerResponse">
    <complexType><sequence>
      <element name="result" type="string"/>
    </sequence></complexType>
  </element>
</schema></types>

<message name="ManufacturerRequestMessage">
  <part element="tns:ManufacturerRequest" name="payload"/>
</message>
<message name="ManufacturerResponseMessage">
  <part element="tns:ManufacturerResponse" name="payload"/>
</message>

<portType name="Manufacturer">
  <operation name="initiate"><input message="tns:ManufacturerRequestMessage"/></operation>
</portType>

... ..

<service name="Manufacturer">
  <port name="ManufacturerSOAP" binding="tns:ManufacturerSOAP">
    <soap:address location="http://eig.stanford.edu/bpel" />
  </port>
</service>
<service name="ManufacturerCallback">
  <port name="ManufacturerCallbackSOAP" binding="tns:ManufacturerCallbackSOAP">
    <soap:address location="http://eig.stanford.edu/bpel" />
  </port>
</service>
</definitions>

```

Schema of the incoming messages

Address for invocation

Figure 25: WSDL file for the deployed BPEL process “Manu D2.2 Receive, Configure, Enter & Validate Order”

SC Collaborator
Welcome, Caleb Cheng! ▾

[Home](#) | [Schedule](#) | [Task Report](#) | [PO Mgt](#) | **[Org Reg](#)** | [Product Info](#) | [SCOR Summary](#) | [PO Prep](#) | [Prod Mon](#)

Organization Registration

Contractor:

Contractor: Electric

Registered Distributors/Plants:

<input type="text" value="Citric"/>	<input type="button" value="Modify"/>	<input type="button" value="Delete"/>
<input type="text" value="Industrial Electric"/>	<input type="button" value="Modify"/>	<input type="button" value="Delete"/>
<input type="text" value="International Electric"/>	<input type="button" value="Modify"/>	<input type="button" value="Delete"/>
<input type="text"/>	<input type="button" value="Add"/>	

Distributor/Plant:

Distributor/Plant: International Electric

Registered Manufacturers/Suppliers:

<input type="text" value="Belight"/>	<input type="button" value="Modify"/>	<input type="button" value="Delete"/>
<input type="text" value="Cober Lighting"/>	<input type="button" value="Modify"/>	<input type="button" value="Delete"/>
<input type="text" value="Corena"/>	<input type="button" value="Modify"/>	<input type="button" value="Delete"/>
<input type="text" value="EIS Lighting"/>	<input type="button" value="Modify"/>	<input type="button" value="Delete"/>
<input type="text" value="HEGS"/>	<input type="button" value="Modify"/>	<input type="button" value="Delete"/>
<input type="text" value="IOM Lighting"/>	<input type="button" value="Modify"/>	<input type="button" value="Delete"/>
<input type="text" value="Kirten"/>	<input type="button" value="Modify"/>	<input type="button" value="Delete"/>
<input type="text" value="Lightec"/>	<input type="button" value="Modify"/>	<input type="button" value="Delete"/>
<input type="text" value="LIMPS"/>	<input type="button" value="Modify"/>	<input type="button" value="Delete"/>
<input type="text" value="NEOPA"/>	<input type="button" value="Modify"/>	<input type="button" value="Delete"/>
<input type="text" value="RSIK Lighting"/>	<input type="button" value="Modify"/>	<input type="button" value="Delete"/>
<input type="text" value="Specta Lighting"/>	<input type="button" value="Modify"/>	<input type="button" value="Delete"/>
<input type="text"/>	<input type="button" value="Add"/>	

Figure 26: General contractor registering the distributors and manufacturers

SCOR Status

Delivery Location: Both Construction site Contractor's warehouse

Contractor:

Distributor/Plant:

Manufacturer/Supplier:

Share:

Start

Flooring

Concrete

Drywall

Electric (owner)

Elevator

Iron Works

Main Construction (shared)

Mechanical (shared)

Plumbing (shared)

Tile Installers

	Product Code	Quantity	Contractor	Distributor	Manufacturer	Site Delivery	Current Status	Estimated Delivery	Actual Delivery
<input type="checkbox"/>	T5-EB120-S91	2	Electric	International Electric	NEOPA	true	<u>D2.3</u>	2009-05-29	null
<input type="checkbox"/>	A35 FSR12056-70-35-80	5	Electric	International Electric	Kirten	true	<u>D2.3</u>	2009-05-29	null
<input type="checkbox"/>	A34 S23XR-1T5-EBXX-SI-52	2	Electric	International Electric	NEOPA	true	<u>D2.3</u>	2009-05-29	null
<input type="checkbox"/>	A36 SL-8190-LED-MBPC-120-W	9	Electric	International Electric	Lightec	true	<u>D2.3</u>	2009-05-28	null
<input type="checkbox"/>	A25-8 8TSN-132-UNV-EB81	4	Electric	International Electric	Cober Lighting	true	<u>D2.3</u>	2009-05-27	null
<input type="checkbox"/>	A25-4 SN-132-UNV-EB81	19	Electric	International Electric	Cober Lighting	true	<u>D2.3</u>	2009-05-27	null
<input type="checkbox"/>	A1A-8 22DP-1T5-EB120-S91	7	Electric	International Electric	NEOPA	true	<u>D2.3</u>	2009-05-26	null
<input type="checkbox"/>	A9-8 CS-SN-1N5-1C-UNV	32	Electric	International Electric	Corena	true	<u>D2.3</u>	2009-05-26	null
<input type="checkbox"/>	A30 MCP70-U-MED-830PB	8	Electric	International Electric	LIMPS	true	<u>D2.3</u>	2009-05-26	null
<input type="checkbox"/>	A31 CF18DT-E-IN-830	12	Electric	International	LIMPS	true	<u>D2.3</u>	2009-05-26	null

Figure 27: SCOR status checking in SC Collaborator

Performance Monitoring

Delivery Location: Both Construction site Contractor's warehouse

Contractor:

Distributor/Plant:

Manufacturer/Supplier:

Delivery Location: Both

Stocked Standard Products (21)

Contractor: Electric Distributor: International Electric Manufacturer: All

Task	Metric Value	Task	Metric Value	Task	Metric Value
Sub P1.4 Est. SC Plans	4	Dist D1.2 Receive, Enter & Validate Order	1		
-- Cycle Time (day)		-- Cycle Time (day)			
Sub P2.4 Est. Sourcing Plans	3	Dist P4.4 Est. Delivery Plans	0.6		
-- Cycle Time (day)		-- Cycle Time (day)			
Sub S1.1 Schedule Prod. Deliveries	1.3	Dist D1.3 Determine Delivery Date	0.5		
-- Cycle Time (day)		-- Cycle Time (day)			
-- Days per Schedule Change	[1-2]	-- % Orders Delivered in Full	[20-30]		
-- Quantity per Shipment	[3-5]	Dist D1.4 Consolidate Orders	0.5		
Sub S1.2 Receive Product	0.8	-- Cycle Time (day)			
-- Cycle Time (day)		Dist D1.6 Route Shipments	0.3		
-- % Orders Received On-Time	100	-- Cycle Time (day)			
-- % Orders Received with Correct Shipping Doc	[90-95]	Dist D1.7 Select Carriers	0.2		
Sub S1.3 Verify Product	0.2	-- Cycle Time (day)			
-- Cycle Time (day)		Dist D1.8 Receive Prod. from S/M	0		
-- % Orders Received Defect Free	[80-90]	-- Cycle Time (day)			
-- % Orders Received with Correct Content	[90-95]	-- % Correct Material Doc	100		
		Dist D1.11 Load Product	0.8		
		-- Cycle Time (day)			
		-- Doc Accuracy	100		
		Dist D1.12 Ship Product	1.1		
		-- Cycle Time (day)			
		-- % Orders Delivered in Full	[20-30]		
		Dist D1.13 Verify by Customer	0.2		
		-- Cycle Time (day)			
		-- % Perfect Condition	[80-90]		

Relatively long time for procurement preparation

Products were delivered on-time, but some with incorrect shipping document

Some products were not delivered in perfect condition

Figure 28: Supply chain performance monitoring in SC Collaborator

Table 1: Examples of supply chain performance metrics used in the case example

SCOR Supply Chain Processes (P: Plan; S: Source; M: Make; D: Deliver)	SCOR Performance Metrics (RL: reliability; RS: responsiveness; CO: costs; AM: asset management)
P1.4 Establish & Communicate Supply-Chain Plans	<ul style="list-style-type: none"> • (RS) Establish Supply Chain Plans Cycle Time
P2.4 Establish Sourcing Plans	<ul style="list-style-type: none"> • (RS) Establish Sourcing Plans Cycle Time
P3.4 Establish Production Plans	<ul style="list-style-type: none"> • (RS) Establish Production Plans Cycle Time
P4.4 Establish Delivery Plans	<ul style="list-style-type: none"> • (RS) Establish Delivery Plans Cycle Time
S1.1 S2.1 S3.3 Schedule Product Deliveries	<ul style="list-style-type: none"> • (RS) Schedule Product Deliveries Cycle Time • (RS) Average Days per Schedule Change • (CO) Quantity per shipment
S1.2 S2.2 S3.4 Receive Product	<ul style="list-style-type: none"> • (RL) % Orders/ Lines Received On-Time • (RL) % Orders/ Lines Received with Correct Shipping Documents • (RS) Receiving Product Cycle Time
S1.3 S2.3S3.5 Verify Product	<ul style="list-style-type: none"> • (RL) % Orders/ Lines Received Defect Free • (RL) % Orders/ lines Received with Correct Content • (RS) Verify Product Cycle Time
M1.1 M2.1 Schedule Production Activities	<ul style="list-style-type: none"> • (RS) Schedule Production Activities Cycle Time • (AM) Capacity Utilization
M2.2 M3.3 Issue Sourced/ In-Process Product	<ul style="list-style-type: none"> • (RS) Issue Sourced/In-Process Product Cycle Time • (CO) Quantity per Shipment
M2.3 Produce and Test	<ul style="list-style-type: none"> • (RL) Yield • (RS) Produce and Test Cycle Time • (AM) Capacity Utilization
D1.1 D2.1 Process Inquiry and Quote	<ul style="list-style-type: none"> • (RS) Process Inquiry & Quote Cycle Time
D1.2 D2.2 Receive, Enter and Validate Order	<ul style="list-style-type: none"> • (RS) Receive, Enter & Validate Order Cycle Time
D1.3 D2.3 Reserve Inventory and Determine Delivery Date	<ul style="list-style-type: none"> • (RL) % of Orders Delivered In Full • (RS) Reserve Inventory & Determine Delivery Date Cycle Time
D1.8 D2.8 D3.8 Receive Product from Source or Make	<ul style="list-style-type: none"> • (RL) % correct material documentation • (RS) Receive Product from Source or Make Cycle Time

Table 2: Conversion table from BPMN elements to BPEL elements

BPMN element type	“activityType” attribute value	Converted BPEL element
Event	EventStartEmpty	<bpws:empty>
Event	EventEndEmpty	<bpws:empty>

Activity	Task, or null	<bpws:empty>
Gateway	GatewayDataBasedExclusive	<bpws:if>, <bpws:elseif>, <bpws:else>
Gateway	GatewayDataBasedInclusive	<bpws:if>
Gateway	GatewayParallel	<bpws:flow>