

NIST EXPERIENCE WITH NON-ROTATING FORCE-BALANCED PISTON GAUGES FOR LOW PRESSURE METROLOGY

Jay H. Hendricks¹ and Douglas A. Olson¹

¹NIST, 100 Bureau Drive, Gaithersburg MD, 20899-8364, jay.hendricks@nist.gov

Abstract – The National Institute of Standards and Technology (NIST) Low Pressure Manometry Project maintains and operates primary standard ultrasonic interferometer manometers (UIMs) over the pressure range of 1 mPa to 360 kPa. Over the past decade a new type of customer gauge, the non-rotating force-balanced piston gauge or FPG (model 8601, DH Instruments, a Fluke Company¹) has been introduced to the standards community that covers the range of ≈ 1 Pa to 15 000 Pa and is capable of both absolute and differential measurement modes. Since 2002, NIST customers² have requested that four different FPG units be compared to the NIST primary pressure manometer standards (UIMs). The results of the comparisons were that all four FPG units were within manufacturers stated uncertainty ($0.008 \text{ Pa} + 30 \times 10^{-6} \times P$ for absolute mode) when compared against the NIST UIMs at pressures between 10 Pa to 15 000 Pa (absolute mode). At pressures between 5 Pa to 10 Pa, the results were generally within manufacturer's specifications. Below 5 Pa some of the FPG units were outside of manufacturer's uncertainty specifications. The use of an isolating capacitance diaphragm gauge (CDG) was necessary during the comparisons to prevent humidified gas from the FPG from entering the NIST 160 kPa mercury UIM primary pressure standard. The results of these four different comparison tests will be discussed in detail, along with test conditions, equipment set-up, and test uncertainty analysis.

Keywords: force balanced piston gauge, FPG, metrology, pressure, standards, vacuum, UIM, ultrasonic interferometer manometer.

1. INTRODUCTION

National metrology institutes (NMIs) and secondary primary standards laboratories (PSLs) from around the world send instruments to the National Institute of Standards and Technology (NIST) to validate the uncertainties claimed by the instrument manufacturers, and to become directly traceable to NIST and the International System of Units, the SI. The NIST Low Pressure Manometry Project maintains

and operates primary standard ultrasonic interferometer manometers (UIMs) over the pressure range 1 mPa (vacuum) to 360 kPa (3.6 times atmospheric pressure). The typical customer gauging technologies used to cover this pressure range have included high-accuracy capacitance diaphragm gauges (CDG), quartz bourdon gauges (QBT) resonance silicon gauges (RSG), piezoresistive transducers (PZT), piston gauges (PG) and NIST-built transfer standard packages (TSP). Since the introduction of the FPG to the standards community in the 1990s, the number of standards laboratories using this instrument as a pressure standard has steadily increased. NIST has compared four different FPG units to the 140 Pa oil UIM and 160 kPa mercury UIM. The results of these comparisons are presented along with the advantages and disadvantages of using this new high-accuracy device to both generate and measure pressures between 0.3 Pa and 15 000 Pa.

2. EQUIPMENT AND TEST CONDITIONS

2.1. NIST UIM Standards

Two NIST standards (shown in Fig. 1) are used to cover the range of the test conditions spanning 0.3 Pa to 15 000 Pa absolute. The NIST UIMs have been previously described in detail [1-6]. For the pressure range of 0.3 Pa to 100 Pa, the NIST 140 Pa oil UIM was used, which has an expanded uncertainty ($k=2$) for $P > 3$ Pa of

$$U_{STD \text{ OilUIM}} = \sqrt{(3 \times 10^{-3} \text{ Pa})^2 + (36 \times 10^{-6} \times P)^2} \quad (1)$$

and for $P \leq 3$ Pa, the expanded uncertainty ($k=2$) is

$$U_{STD \text{ OilUIM}} = \sqrt{(0.7 \times 10^{-3} \text{ Pa})^2 + (1 \times 10^{-3} \times P)^2} \quad (2)$$

where P is the pressure in Pa. For the pressure range of 100 Pa to 15 000 Pa, the NIST 160 kPa mercury UIM was used, which has an expanded uncertainty ($k=2$) of

$$U_{STD \text{ HgUIM}} = \sqrt{(6 \times 10^{-3} \text{ Pa})^2 + (5.2 \times 10^{-6} \times P)^2} \quad (3)$$

¹Certain commercial equipment, instruments, or materials are identified in this paper to foster understanding. Such identification does not imply endorsement by NIST nor does it imply that the equipment or materials are necessarily the best for the purpose.

²NIST customers shall not be identified.

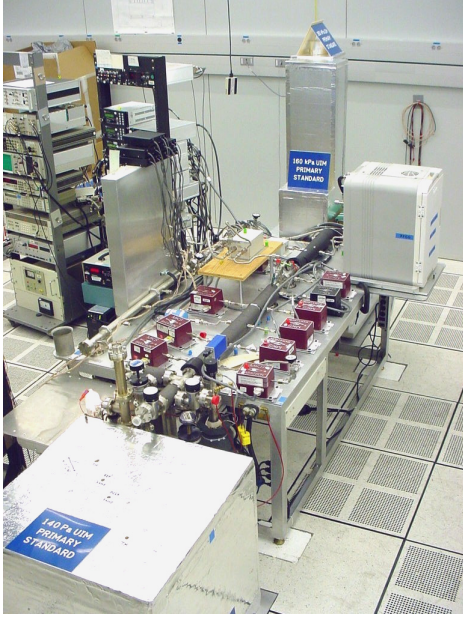

Fig. 1. Shown above is the NIST Low Pressure Manometer Laboratory showing the NIST 140 Pa Oil UIM (foreground) and 160 kPa Mercury UIM (background) conducting tests of NIST customer CDGs and RSGs.

2.2. FPG

The new non-rotating force balanced piston gauge is based upon a mass comparator to determine the force applied to a nominal effective area of 980 mm^2 . Shown in Fig. 2 is a schematic of the FPG [7]. The principle of operation is similar to traditional rotating piston gauges where the pressure applied to the effective area of a piston-cylinder is transformed into a proportional force. The major difference, however, is that the counter balancing force on a rotating piston gauge is generated by applying calibrated masses in a known gravitation field. By contrast, the FPG measures the force generated from a given gas pressure against a force balanced load cell to which the piston is attached. The required attaching linkage prevents the piston from rotating, and therefore requires a piston to be machined with a conical shape to ensure centering of the piston in the gap, and also requires that a “lubricating gas flow” enter the piston at mid-stroke. The load cell is zeroed with high-side, P_{hi} , and low-side, P_{ref} , chambers connected (at the same pressure) which tares out the mass of the piston plus any residual forces not associated with measuring pressure. In absolute mode, a precision capacitance diaphragm gauge measures the reference pressure on the low side of the FPG device. The FPG utilizes a VLPC (very low pressure controller) to set and maintain pressures between the P_{hi} and P_{ref} of the instrument, as shown in Fig. 2.

The manufacturer’s stated uncertainty ($k=2$) for the FPG given for absolute mode measurements is

$$U_{FPG} = 0.008 \text{ Pa} + 30 \times 10^{-6} \times P \quad (4)$$

where P is the pressure in Pa. By comparing indicated FPG pressure against the NIST primary pressure standards and developing an uncertainty statement for the test, it was

possible to compare the manufacturers’ uncertainty statement at the test conditions to determine if the instrument was “within tolerance” of the manufacturer’s stated uncertainty.

Prior to the NIST tests, the shipped FPGs and associated equipment were allowed to reach thermal equilibrium for at least 48 hours before they were unpacked and set-up (see Fig. 3.). For all tests, a trained operator was sent by the equipment manufacturer to operate the FPG and to assist with set-up and tear-down of the equipment. After the equipment was installed, the FPG piston was carefully cleaned, and the instrument was left overnight to stabilize (or in some cases was monitored until zero stability was observed). (see Fig. 4).

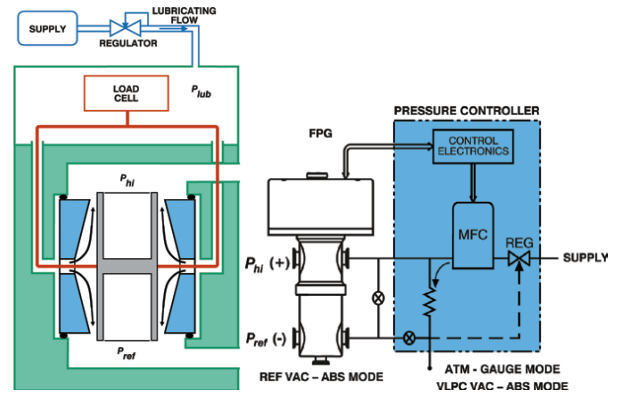

Fig. 2. Shown above is a schematic of the non-rotating conical piston/cylinder assembly, load cell with interconnecting linkage, and lubricating gas flow. Also shown is the pressure control for the high/low side of the FPG referred to as the VLPC. Schematic figures used with the manufacturer’s expressed written permission.



Fig. 3. Shown above is an FPG unit under test at NIST being compared to the 140 Pa Oil UIM and the 160 kPa mercury UIM pressure standards.

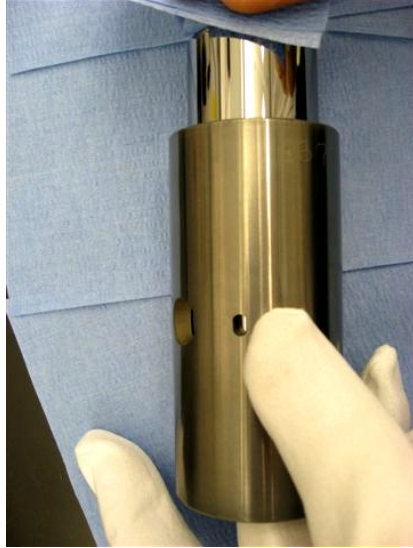

Fig. 4. FPG Piston is removed and cleaned (Robert Haines, DHI). After cleaning, the FPG instrument was left overnight to stabilize (or until zero stability was obtained) before test measurements were recorded.

To reduce the static-charging effects in the mass comparator, the piston “lubricating gas flow” is humidified with water to reach a humidity level of 50 % (see Fig. 2). To prevent water vapour from entering the NIST 160 kPa UIM standard and to prevent mercury vapour from entering the FPG, a MKS high-accuracy differential 133 Pa CDG was employed as an isolating null-detector between the two systems (shown in Fig. 5). The high-pressure side of the CDG was connected to the mercury UIM manifold and a bypass valve enabled the CDG to be zeroed.

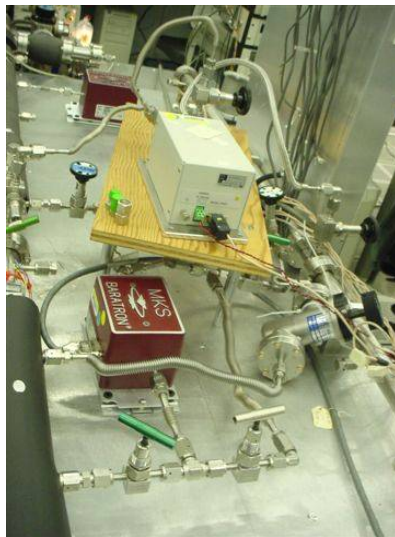

Fig. 5. Shown above is an MKS high-accuracy 133 Pa differential capacitance diaphragm gauge (CDG) used as a null detector between the NIST 160 kPa UIM and the FPG. Use of the null detector increased only slightly the uncertainty of the comparison, and prevented water vapour from the FPG lubricated gas flow from entering the NIST mercury UIM primary standard.

2.3. Test Conditions

Four different FPG units (identified as FPG A through D) were compared to the NIST 140 Pa oil UIM over the range of 5 Pa to 100 Pa in absolute mode, and the 160 kPa mercury UIM over the range of 100 Pa to 15 000 Pa in absolute mode. The comparisons were performed using nitrogen gas at the following ascending nominal pressures: (5, 10, 30, 60, and 100) Pa versus the 140 oil UIM, and (100, 250, 500, 1000, 2500, 5000, 10 000, and 15 000) Pa versus the 160 kPa Hg UIM. In the case of two FPG units, pressures lower than 5 Pa were evaluated. An isolation valve was placed between the NIST UIM pressure manifold and the FPG high pressure side. With zero pressure applied across the FPG high side, P_{hi} , and low-side, P_{ref} , FPG zero was set. To set each pressure, the isolation valve was closed, and the NIST UIM and FPG were each set to the nominal pressure to be measured. Only when the nominal pressure was established in both instruments was the isolation valve opened. This procedure prevented the FPG’s VLPC (see Fig. 2) from setting large pressure changes in large volumes. Failure to use the isolation valve resulted in long pressure stabilization times. After establishing a selected pressure in the UIM manifolds and the FPG, the measurement system was allowed to equilibrate, nominally for 5 to 10 minutes. A nominal set of 5 to 9 “simultaneous” pressure readings were recorded for the FPG and the UIM, as well as for the isolating CDG during comparisons with the mercury UIM. The typical synchronized pressure measurement integration time was 30 s. The FPG was isolated from the manometer manifold and its zero-pressure reading was re-set to zero before proceeding to the next measured pressure. Typically, but not in all cases, FPG zero-pressure reading, $Z_{CORR\ FPG}$ was measured between pressure points and prior to resetting the FPG zero.

For the comparison in the range of 5 Pa to 100 Pa:

Differences in operating temperatures between the FPG and oil UIM primary standard can give rise to thermal transpiration effects [8] that can be non-negligible at pressures below 100 Pa. This can occur since the operating temperature of the NIST UIM, $t_1=t_{UIM}$, and temperature of the FPG, $t_2=t_{FPG}$ are not identical. The pressure that the FPG would have generated if it were operating at the identical UIM temperature was derived from the zero corrected reading of the FPG at t_2 and use of the formulation in [8] with the following values for the parameters: $d=16$ mm (minimum internal diameter of the interconnecting plumbing) and $A^*=1.2 \times 10^6$, $B^*=1.0 \times 10^3$, $C^*=14$ given for nitrogen calibration gas.

First, the readings of the FPG, $R_{FPG}(t_2)$, were corrected for the FPG zero offset, $Z_{CORR\ FPG}$ to determine FPG reading at its operating temperature $P_{FPG}(t_2)$:

$$P_{FPG}(t_2) = R_{FPG}(t_2) - Z_{CORR\ FPG} \quad (5)$$

Next, the thermal transpiration correction was applied to the readings of the FPG at t_2 such that:

$$P_{FPG} = P_{FPG}(t_2) + P_{TTC} \quad (6)$$

where P_{FPG} is the pressure that the FPG would have generated if it had been at the operating temperature (t_1) of the oil UIM, P_{TTC} is the thermal transpiration correction due to the temperature difference between the oil UIM and the FPG.

For the comparison in the range of 100 Pa to 15 000 Pa:

The results of the comparison between the FPG and the 160 kPa UIM did not require the thermal transpiration corrections described above, however, the null-indicating CDG and the effect of mercury vapour pressure from the mercury manometer were addressed by the following expression:

$$P_{STD} = P_{UIM\ Hg} + Hg_{VP} - R_{CDG} \quad (7)$$

where P_{STD} is the final value for the NIST UIM 160 kPa UIM standard, $P_{UIM\ Hg}$ is the reading of the mercury UIM, Hg_{VP} is the mercury vapour pressure at the high-pressure-side of the isolating differential CDG, and R_{CDG} is the zero-corrected reading of the differential CDG during the measurement integration period.

Final values for the FPG, P_{FPG} , were determined by Eqn. 5 and Eqn. 6 except that the contribution of P_{TTC} is negligible:

$$P_{FPG} = P_{FPG}(t_2) \quad (8)$$

Finally, the differences between the reading of the FPG, P_{FPG} , Eqn. 8, and the NIST 160 kPa Hg UIM standard, P_{STD} , eqn. 7, were evaluated such that:

$$\langle P_{FPG} - P_{STD} \rangle = P_{FPG}(t_2) - [P_{UIM\ Hg} + Hg_{VP} - R_{CDG}] \quad (9)$$

The differences between the FPG, P_{FPG} , eqn. 6, and the NIST 140 Pa oil UIM standard, (P_{STD}) were evaluated:

$$\langle P_{FPG} - P_{STD} \rangle = P_{FPG}(t_2) + P_{TTC} - P_{UIM\ OIL} \quad (10)$$

where $P_{UIM\ OIL}$ is the reading of the NIST 140 Pa Oil UIM.

2.4. Uncertainty of Test Results

The uncertainty of the test results U_c was estimated by combining component uncertainties using the root-sum-square method [9].

$$U_c = \sqrt{\sum_i (U_A)_i^2 + \sum_j (U_B)_j^2} \quad (11)$$

where the $(U_A)_i$ are component uncertainties that are evaluated by statistical methods and $(U_B)_j$ are component uncertainties that are evaluated by means other than statistical methods. The combined expanded ($k=2$) uncertainties for the mean difference between the pressure measured by the FPG, P_{FPG} , and the NIST UIM standard, P_{STD} , excluding the Type B uncertainty of the FPG, was estimated by

$$U_c = \sqrt{U_{STD}^2 + U_{RDM}^2 + U_{CDG}^2 + U_{ZFPG}^2} \quad (12)$$

where U_{STD} is the uncertainty due to systematic effects in the UIM primary standards, as given by Eqn. 1, Eqn. 2, or Eqn. 3, U_{RDM} is the combined contribution due to random effects in the NIST standards, the FPG, and the interconnecting manifold, U_{CDG} is the uncertainty due to the differential CDG (the mercury UIM only). U_{ZFPG} is the uncertainty in making the zero-drift correction for the FPG.³

The uncertainty due to random effects was estimated (Type A) from

$$U_{RDM} = 2 \frac{\sigma}{\sqrt{N}} \quad (13)$$

where σ is the standard deviation of N values of $P_{FPG} - P_{STD}$ about their mean.

The uncertainty (U_{CDG}) arising from the CDG readings (R_{CDG}) when comparing the Hg UIM were accounted for by assuming (Type B) the CDG reading were within 5% of the true pressure, since CDG inaccuracies are not usually greater than this.

The uncertainty (U_{ZFPG}) due to drift in the FPG zero at a given pressure was modelled (Type B) by a rectangular distribution [9] for each group of measurements, such that there is an equal probability that the FPG zero lies somewhere between zero-pressure readings taken just before and immediately after a given group of measurements.

3. RESULTS

The mean differences between the FPG devices under test (FPG units A-D) and the NIST UIM primary standards (140 Pa UIM and 160 kPa mercury UIM), $\langle P_{FPG} - P_{STD} \rangle$, were determined along with the component uncertainties of the mean differences as defined by eqn. (9) and (10). For pressures between 0.35 Pa and 100 Pa, P_{FPG} is defined by eqn. (6) and P_{STD} is defined as the reading of the NIST 140 Pa oil UIM; for pressures between 100 Pa and 15 000 Pa, P_{FPG} is defined by eqn. (8) and P_{STD} is defined by eqn. (7) for pressures recorded with the NIST 160 kPa mercury UIM. The mean differences of the FPG from the NIST UIM primary pressure standards are plotted in Figures 6 through 13. The solid lines represent the uncertainty due to systematic effects in the FPG as stated by the manufacturer, eqn. (4). The error bars are the combined uncertainties in the test results (excluding the uncertainty due to systematic effects in the FPG) given by eqn. (12).

³ When unit D was compared to the NIST standards, U_{ZFPG} was not evaluated.

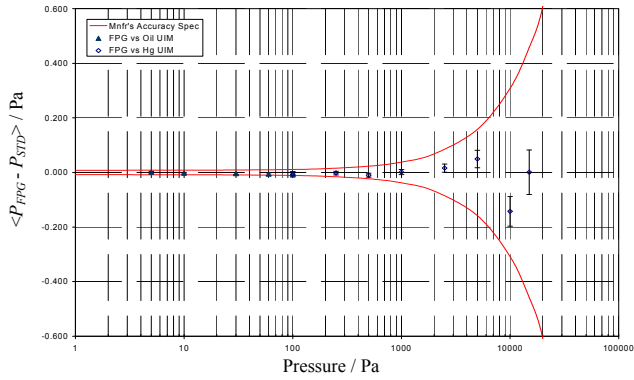

Fig. 6. Shown above is an FPG unit “A” under test at NIST being compared to the 140 Pa oil UIM (5 Pa to 100 Pa) and the 160 kPa mercury UIM (100 Pa to 15 000 Pa). The solid lines represent the uncertainty due to systematic effects in the FPG as stated by the manufacturer. The error bars represent the combined uncertainties in the test results excluding the uncertainty due to systematic effects in the FPG.

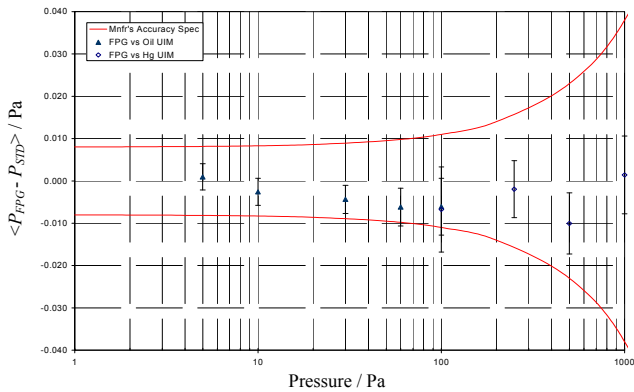

Fig. 7. Shown above is an FPG unit “A” under test at NIST and being compared to the 140 Pa oil UIM (5 Pa to 100 Pa) and the 160 kPa mercury UIM (100 Pa to 1 000 Pa). The solid lines represent the uncertainty due to systematic effects in the FPG as stated by the manufacturer. The error bars represent the combined uncertainties in the test results excluding the uncertainty due to systematic effects in the FPG.

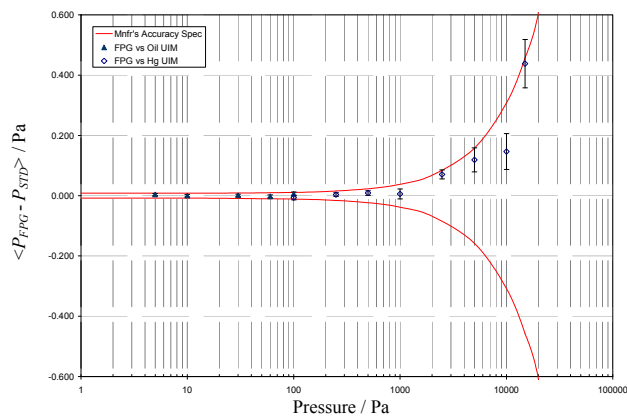

Fig. 8. Shown above is an FPG unit “B” under test at NIST being compared to the 140 Pa oil UIM (5 Pa to 100 Pa) and the 160 kPa mercury UIM (100 Pa to 15 000 Pa). NOTE: During this test the effective area used to calculate pressure in DHI software was 980.5024 mm². Upon return of the FPG8601 DHI re-determined the effective area and found it to be 980.5226 mm². This re-determined value represents an approximate -20 parts per million change in output by the FPG8601 that is not represented in the results shown in the above figure.

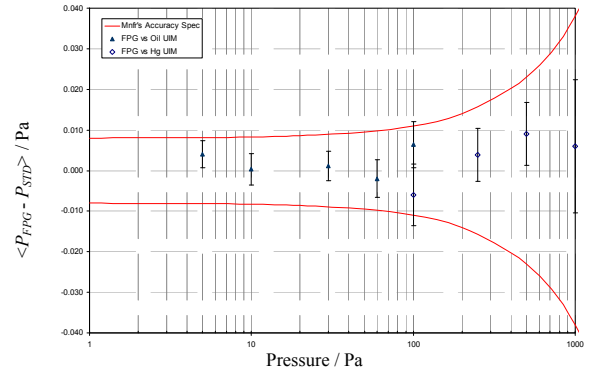

Fig. 9. Shown above is an FPG unit “B” under test at NIST being compared to the 140 Pa oil UIM (5 Pa to 100 Pa) and the 160 kPa mercury UIM (100 Pa to 1 000 Pa). The solid lines represent the uncertainty due to systematic effects in the FPG as stated by the manufacturer. The error bars represent the combined uncertainties in the test results excluding the uncertainty due to systematic effects in the FPG.

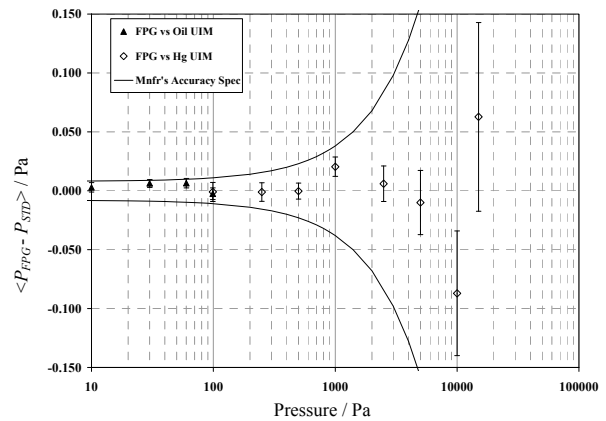

Fig. 10. Shown above is an FPG unit “C” under test at NIST being compared to the 140 Pa oil UIM (10 Pa to 100 Pa) and the 160 kPa mercury UIM (100 Pa to 15 000 Pa). The solid lines represent the uncertainty due to systematic effects in the FPG as stated by the manufacturer. The error bars represent the combined uncertainties in the test results excluding the uncertainty due to systematic effects in the FPG.

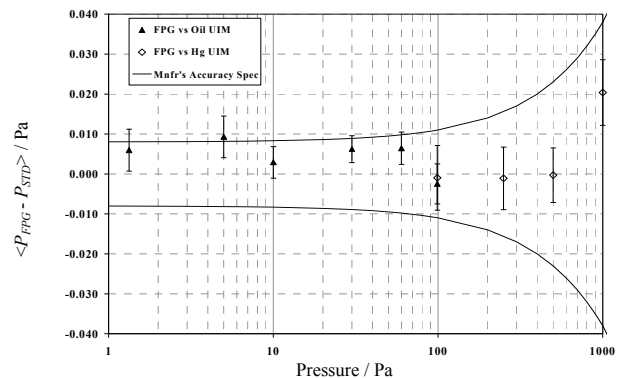

Fig. 11. Shown above is an FPG unit “C” under test at NIST being compared to the 140 Pa oil UIM (10 Pa to 100 Pa) and the 160 kPa mercury UIM (100 Pa to 1 000 Pa) showing low pressure data below 10 Pa that were not requested in the test requirements. The solid lines represent the uncertainty due to systematic effects in the FPG as stated by the manufacturer. The error bars represent the combined uncertainties in the test results excluding the uncertainty due to systematic effects in the FPG.

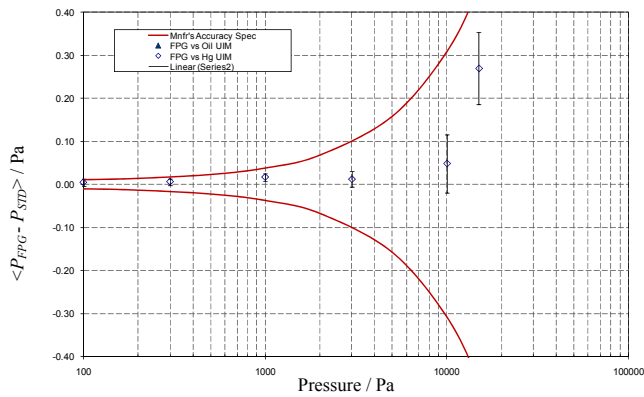

Fig. 12. Shown above is an FPG unit “D” under test at NIST being compared to the 160 kPa mercury UIM (100 Pa to 15 000 Pa). The solid lines represent the uncertainty due to systematic effects in the FPG as stated by the manufacturer. The error bars represent the combined uncertainties in the test results excluding the uncertainty due to systematic effects in the FPG.

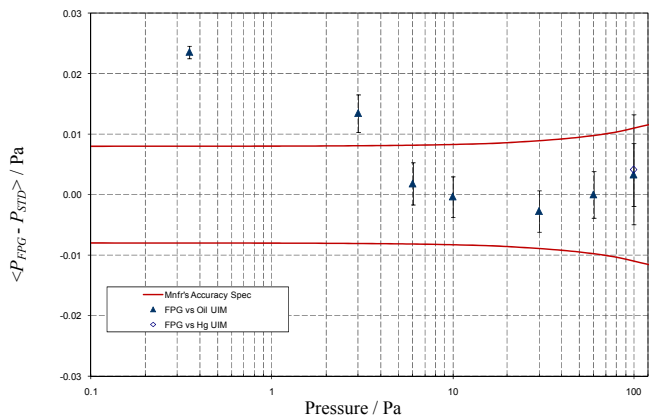

Fig. 13. Shown above is an FPG unit “D” under test at NIST being compared to the 140 Pa oil UIM (0.35 Pa to 100 Pa). The solid lines represent the uncertainty due to systematic effects in the FPG as stated by the manufacturer. The error bars represent the combined uncertainties in the test results excluding the uncertainty due to systematic effects in the FPG.

4. DISCUSSION

The results of the comparisons conducted at NIST demonstrated the FPG units were generally within manufacturers stated uncertainty ($0.008 \text{ Pa} + 30 \times 10^{-6} \times P$ for absolute mode) with a few noted exceptions. The higher pressure comparisons between the FPGs and NIST 160 kPa UIM showed good agreement with the manufacturer’s uncertainty specifications (see Fig. 6, Fig. 11, and Fig. 12). However, Fig. 8 shows an example where the FPG unit under test demonstrated high pressure performance where some measurements were close to being outside of the manufacturers uncertainty specifications. In this case, it was discovered by the manufacturer after the conclusion of the NIST test, that an incorrect and independently determined effective area of the FPG piston had been present in the FPG unit’s software during the NIST test. The true area was later added to unit B’s software (but is not

reflected in Fig. 8) and represents a -20 part per million change, which brings the corrected unit back inside the manufacturer’s specification. With this correction of unit B’s effective area, all four units performed within manufacturer’s uncertainty specifications for pressures between 100 Pa and 15 000 Pa.

The lower pressure comparisons between the FPGs and the NIST 140 Pa oil UIM also showed in-tolerance agreement with the exception of the lowest pressures which were sometimes outside of the manufacturer’s specifications. Unit A (Fig. 7) and unit B (Fig. 9) showed excellent agreement at pressures down to 5 Pa. However unit D (Fig. 13) showed significant deviations at 0.35 Pa and 3 Pa and were outside the manufacturer’s specification. However, for pressures greater than or equal to 6 Pa, Unit D was within specification. We note that for Unit D, the uncertainty component U_{ZFPG} was not evaluated. However, had it been of the same magnitude as the other units, the deviation at 0.35 Pa and 3 Pa would still be significant. Unit C (Fig. 10) also showed good agreement for pressures between 10 Pa and 100 Pa, but also showed near out-of-tolerance performance at the lowest pressures of 1.3 Pa and 5 Pa (Fig. 11).

The FPG has demonstrated accurate measurement performance for pressures between 10 Pa and 15 000 Pa. Because it operates in absolute mode, it can measure pressures not covered by conventional rotating piston gauges. While the FPG cannot be considered a primary standard in the same fashion as the conventional rotating piston gauge, it does have applications where it is very useful. It is important to realize that the FPG requires the lubricating flow which centers the piston in the gap be humidified to 50 % with water to reduce static charging effects in the FPG load cell. Therefore, that use of an FPG on ultra high vacuum (UHV) systems should be avoided unless a null-indicating CDG is used to isolate water vapor from entering the UHV system.

5. CONCLUSIONS

The results of the comparisons conducted at NIST demonstrated that all four FPG units were within manufacturers stated uncertainty ($0.008 \text{ Pa} + 30 \times 10^{-6} \times P$ for absolute mode) when compared against the NIST UIMs at pressures between 10 Pa to 15 000 Pa when operated in absolute mode. For pressures between 5 Pa to 10 Pa the results were within manufacturer’s specifications, but were marginal. However, below 5 Pa, some results were outside of manufacturer’s uncertainty specifications. These results indicate that caution is warranted if using the FPG as a standard with manufacturer’s stated specifications at pressures below 5 Pa. The use of an isolating capacitance diaphragm gauge (CDG) was necessary for the comparisons to prevent humidified gas from the FPG from entering the NIST 160 kPa mercury UIM primary pressure standard and is a recommended practice for applications involving and FPG and high vacuum standards.

ACKNOWLEDGMENTS

The authors acknowledge the assistance of Robert Haines of DH Instruments, a Fluke Company, for his skilled operation of the FPG while at NIST. The author also acknowledges Dr. Archie P. Miiller for his work on the early FPG units prior to his retirement from NIST.

REFERENCES

- [1] Heydemann P L, Tilford C R and Hyland R W 1977 *J. Vac. Sci. Technol.* **14** 597-605A.
- [2] Tilford C R 1977 *Applied Opt.* **16** 1857-1860.
- [3] Tilford C R 1987 *Metrologia*, 1987 **24** 121-131.
- [4] Tilford C R, Miiller A P and Lu S *Proc. Proc. NCSL Workshop & Symposium, Session 3B*, 1998, 245-256.
- [5] Miiller A P, Tilford C R and Hendricks J H 2005 *Metrologia* **42** S187-S192.
- [6] Schmidt J W, Jain K, Miiller A P, Bowers W J and Olson D A 2006 *Metrologia* **43** 53-59.
- [7] Delajoud P, Girard M N, *NCSLI Conference*, San Diego, August 2002.
- [8] Poulter K F, Rodgers M J, Nash P J, Thompson T J, Perkin M P, *Vacuum*, 1983, **33** (6) 311-316.
- [9] Taylor B N and Kuyatt C E, NIST Technical Note 1297 (1994).